



# NVSAIR

ventilation for life



## ÜRÜN KATALOĞU

NPAF - Plastik Kanatlı Duvar Tipi  
Aksiyel Fan



+90 533 576 25 71



[www.nvsair.com](http://www.nvsair.com)



[info@nvsair.com](mailto:info@nvsair.com)

## ► NPAF (Plastik Kanatlı Duvar Tipi Aksiyel Fan)

NPAF Fan kare gövdesi ile duvara kolay montaj imkanı sağlar. Standart olarak koruma teli ve elektrostatik toz boyalı üretilir. İsteğe göre kanatlar alüminyum takılabilir. Hava akış yönü motordan pervaneye DOĞRUDUR.

**Not:** 5,50 kW ve üzeri cihazlarda Yıldız-Üçgen Pano veya Frekans Konvertörü KULLANILMALIDIR.



### TANIM

### DEĞER

MOTOR YALITIM SINIFI	F SINIFI
MOTOR KORUMA SINIFI	IP 55
MOTOR VERİM SINIFI	IE3
GÖVDE MALZEMESİ	GALVANİZE SAC
GÖVDE KAPLAMASI	ELEKTRO-STATİK TOZ BOYA
PERVANE MALZEMESİ	ALÜMİNYUM
GÖREV DÖNGÜSÜ	IEC Duty Cycle-S1
ÇALIŞMA SICAKLIĞI	-20 - +50 °C
STANDARTLAR	en 60204-1



Motor Hava Akımının İçinde



Egzoz



Basınçlandırma



Duvara Monte



MODEL	VOLTAJ (V)	FREKANS (Hz)	GÜÇ (kW)	DEVİR (rpm)	DEBİ (m³/h)	SES SEVİYESİ (dB(A))
NPAF 400-5-25	380	50	0,37	1.450	2.895	66
NPAF 450-5-25	380	50	0,55	1.456	4.180	69
NPAF 500-5-25	380	50	0,55	1.453	5.845	72
NPAF 560-5-25	380	50	0,75	1.466	8.150	75
NPAF 630-5-30	380	50	1,10	1.465	13.480	80
NPAF 710-5-30	380	50	1,50	1.472	19.210	83
NPAF 800-5-30	380	50	2,20	1.459	25.560	85
NPAF 800-5-35	380	50	3,00	1.463	30.940	89
NPAF 900-5-35	380	50	4,00	1.471	39.250	90
NPAF 900-5-40	380	50	5,50	1.472	44.635	93
NPAF 1000-5-40	380	50	7,50	1.478	54.570	94

Değerler 0 Pa içindir

### TEKNİK RESİM

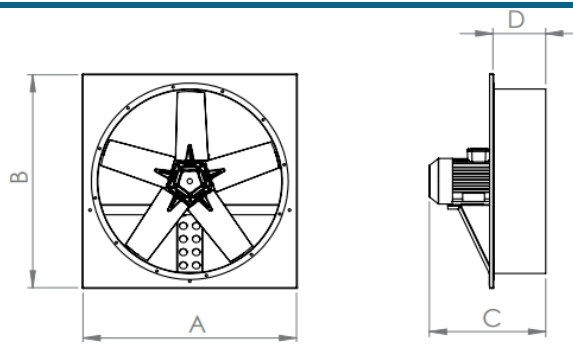

MODEL	A (mm)	B (mm)	C (mm)	D (mm)
NPAF 400	570	570	400	200
NPAF 450	610	610	410	200
NPAF 500	650	650	410	200
NPAF 560	680	680	410	200
NPAF 630	750	750	420	200
NPAF 710	830	830	450	200
NPAF 800	920	920	480	200
NPAF 900	1020	1020	590	300
NPAF 1000	1120	1120	700	300



+90 533 576 25 71



www.nvsair.com



info@nvsair.com

## DİĞER OPSİYONLAR



İstenilen Renkte  
Elektro-Statik Toz Boya



Alüminyum veya Plastik  
Kanat Seçeneği



İstenilen Debi ve  
Basınca Özel Üretim



Sistem Otomasyonu



5, 8, 12 ve 16 Kanat  
Adedi Seçenekleri



Çift Devirli Motor  
Seçeneği

## PERFORMANS EĞRİLERİ

NPAF 400-5-25

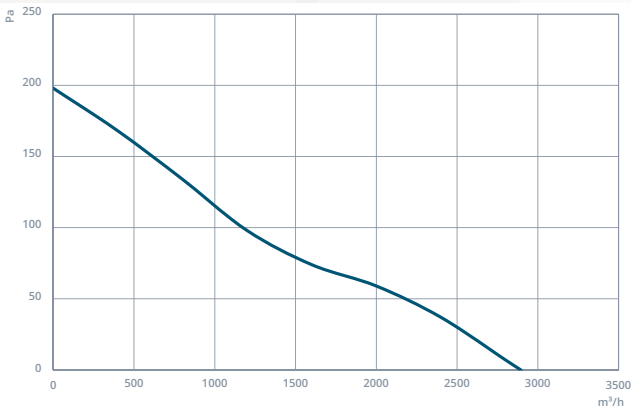

NPAF 450-5-25

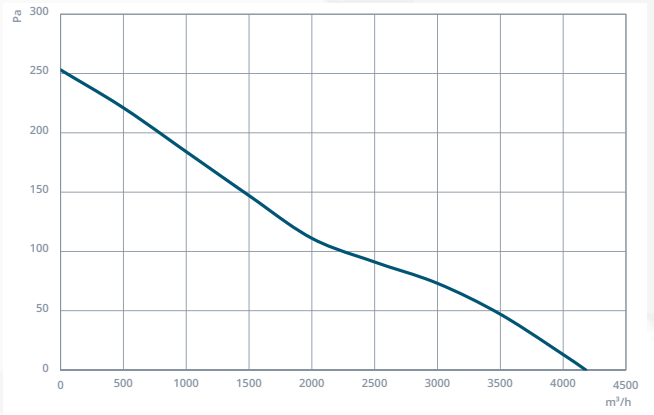

NPAF 500-5-25

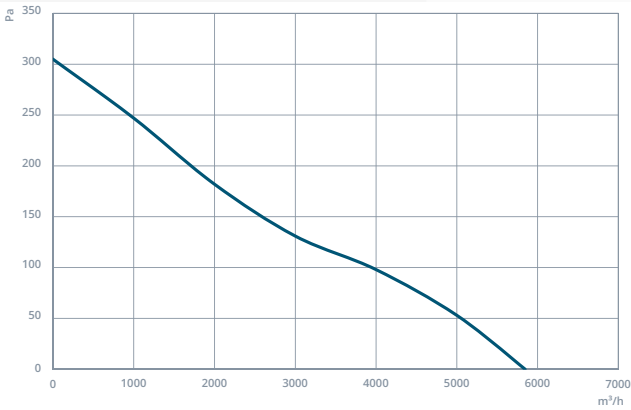

NPAF 560-5-25

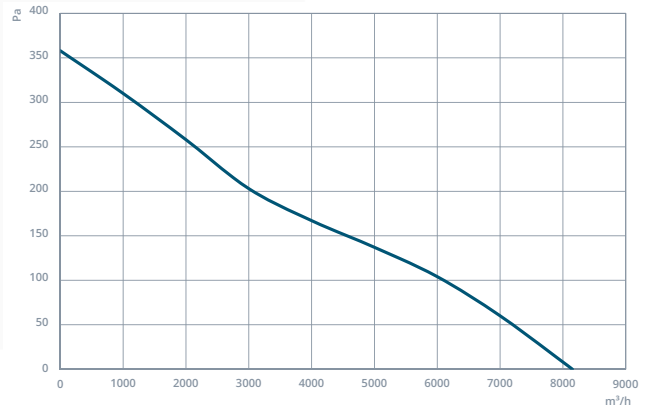

+90 533 576 25 71



www.nvsair.com



info@nvsair.com

## PERFORMANS EĞRİLERİ

### NPAF 630-5-30

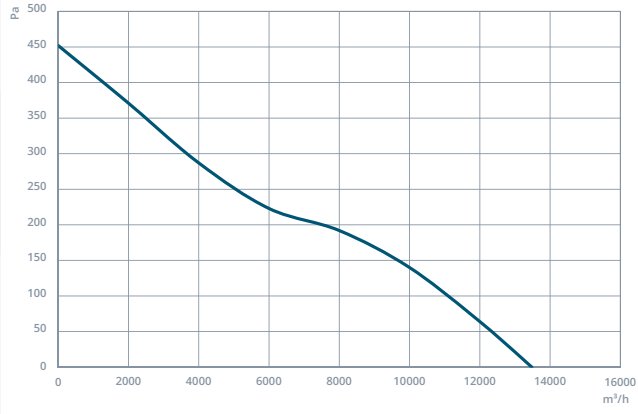

### NPAF 710-5-30

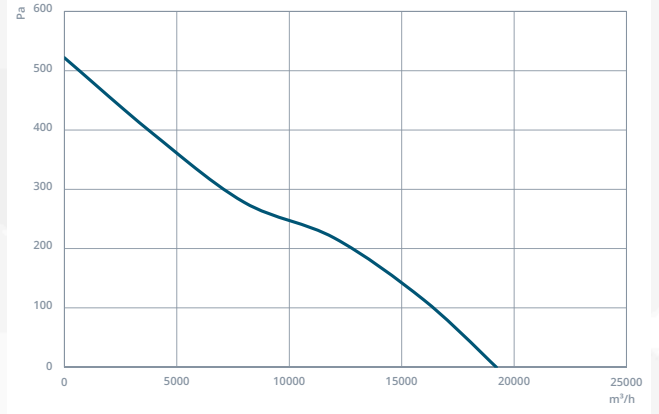

### NPAF 800-5-30

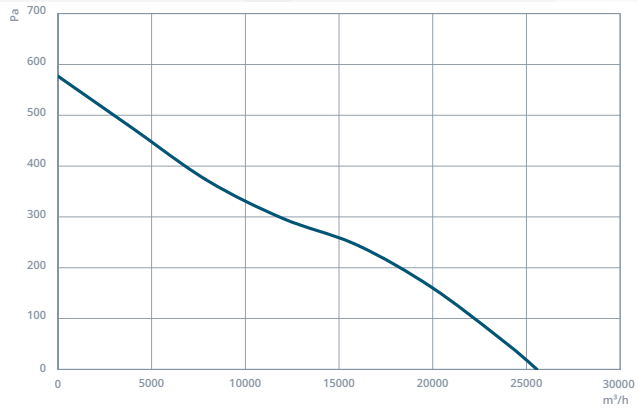

### NPAF 800-5-35

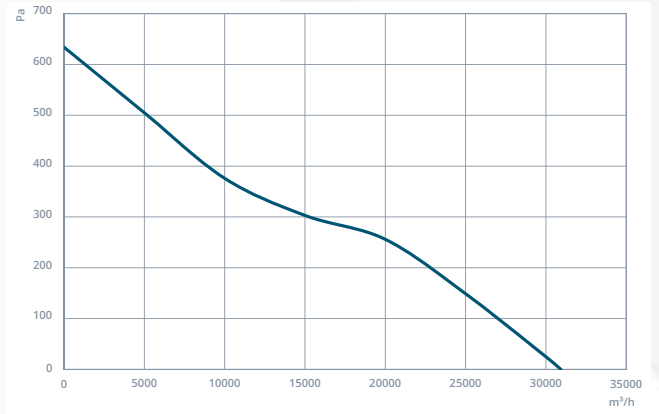

### NPAF 900-5-35

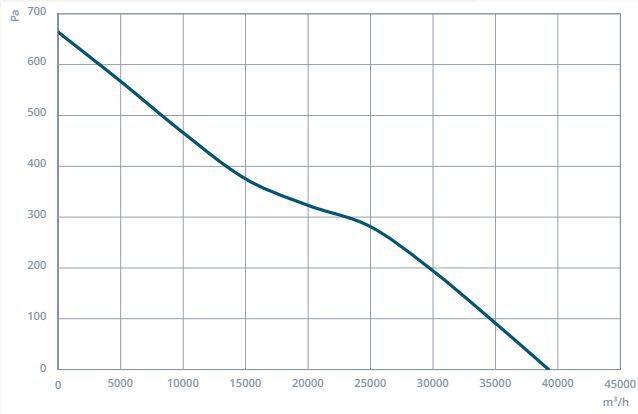

### NPAF 900-5-40

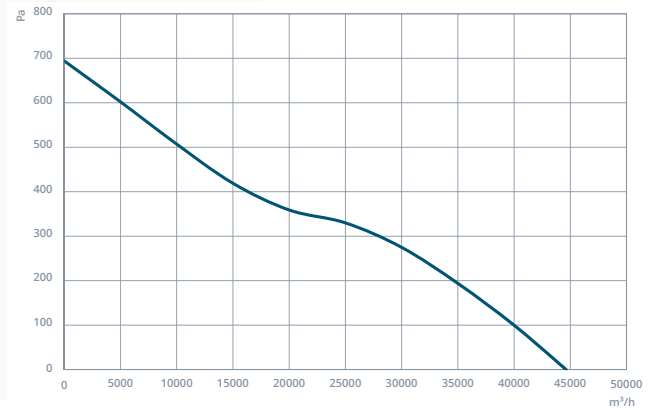

### NPAF 1000-5-40

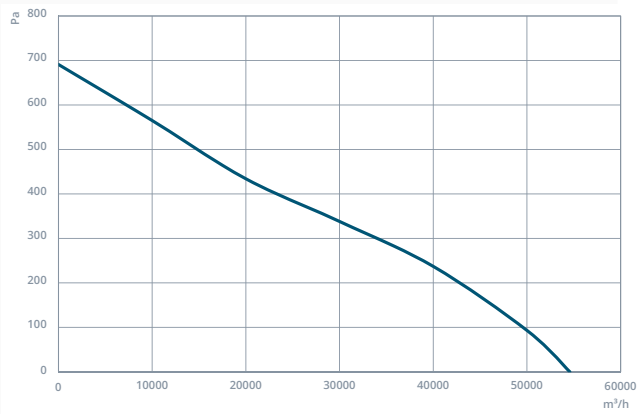



## ***İLETİŞİM***

.....

**Batı Sitesi Mah. 2310. Cad. No:50  
Yenimahalle, Ankara, Türkiye**

**Tel: +90 533 576 25 71**

**info@nvsair.com  
nvsair.com**