



NVSAIR

ventilation for life



ÜRÜN KATALOĞU

NMFF - Karma Akışlı Plastik Fan



+90 533 576 25 71



www.nvsair.com



info@nvsair.com

► NMFF (Karma Akışlı Plastik Fan)

NMFF fanlar karma akışlı pervanesi ve verimli motoru ile havalandırma sistemlerinizde kullanılabilir. V0 yanmazlık sınıfında alev yürütme özelliğine sahiptir

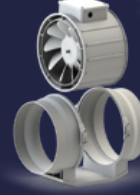

TANIM

DEĞER

MOTOR YALITIM SINIFI	F SINIFI
MOTOR KORUMA SINIFI	IP 44
MOTOR VERİM SINIFI	-
GÖVDE MALZEMESİ	PLASTİK
GÖVDE KAPLAMASI	-
PERVANE MALZEMESİ	PLASTİK
GÖREV DÖNGÜSÜ	IEC Duty Cycle-S1
ÇALIŞMA SICAKLIĞI	-20 - +50 °C
STANDARTLAR	EN 60204-1



Motor Hava Akımının İçinde



Egzoz



Basınçlandırma



Kanala Monte

TURKEY

EAC

TSEK

TSE

K. S. 2000

CE

MODEL	VOLTAJ (V)	FREKANS (Hz)	GÜÇ (W)	DEVİR (rpm)	DEBİ (m³/h)	SES SEVİYESİ (dB(A))
NMFF 100	230	50	54	2.460	234	31
NMFF 125	230	50	56	2.560	337	32
NMFF 150	230	50	75	2.490	504	33
NMFF 160	230	50	75	2.490	560	33
NMFF 200	230	50	111	2.410	1.012	36
NMFF 250	230	50	280	2.460	1.350	38
NMFF 315	230	50	476	2.476	1.970	42

Değerler 0 Pa içindir.

TEKNİK RESİM

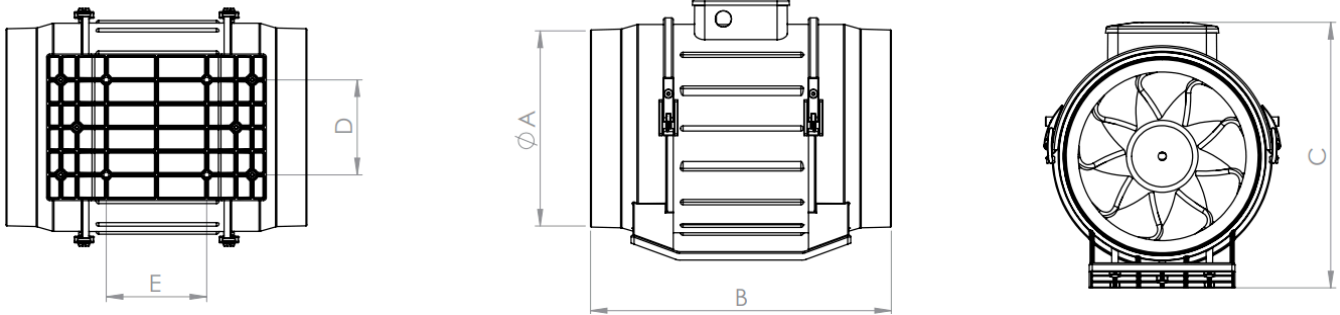

MODEL	A (mm)	B (mm)	C (mm)	D (mm)	E (mm)
NMFF 100	96	306,5	215	60	80
NMFF 125	121	260	215	60	80
NMFF 150	146	290,5	242	60	80
NMFF 160	156	271	242	60	80
NMFF 200	191	300	263	94	100
NMFF 250	246	393	325	110	140
NMFF 315	310	450	420	175	180



+90 533 576 25 71



www.nvsair.com



info@nvsair.com

PERFORMANS EĞRİLERİ

NMFF 100

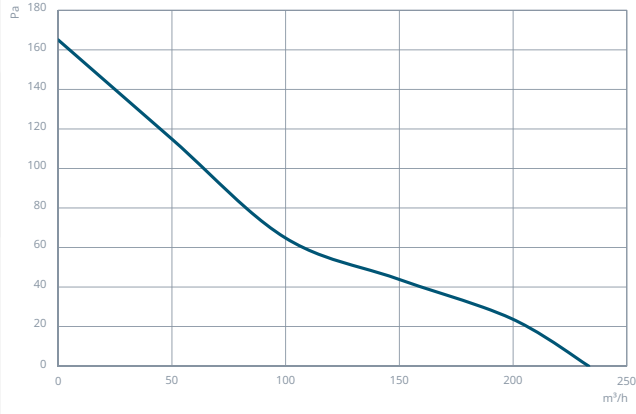

NMFF 125

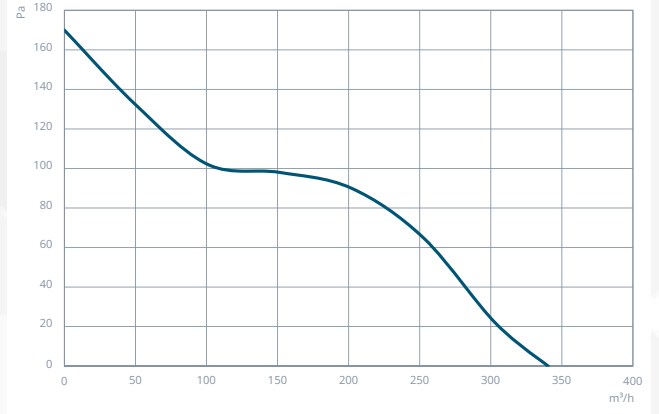

NMFF 150

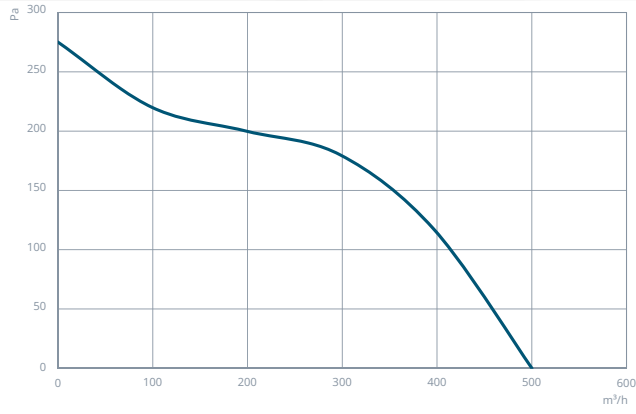

NMFF 160

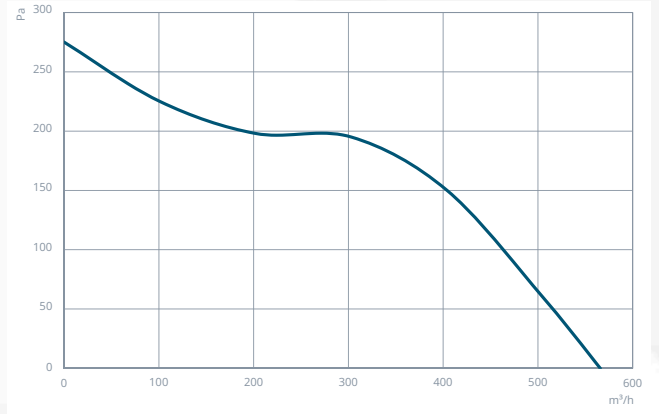

NMFF 200

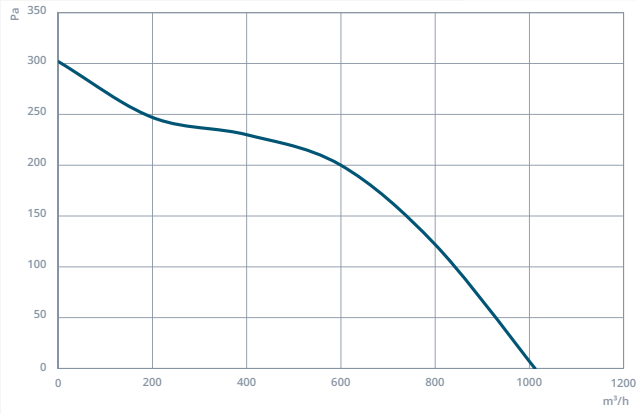

NMFF 250

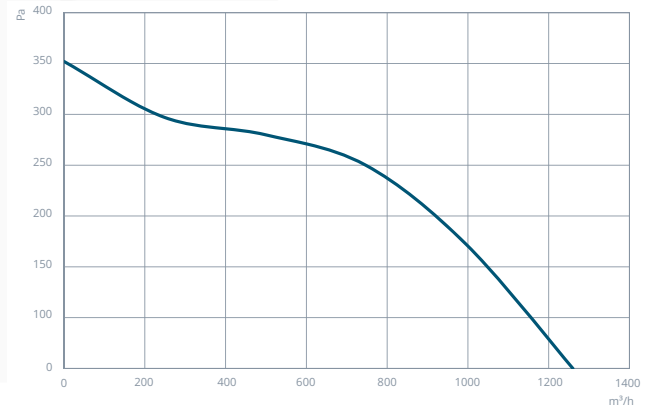

NMFF 315

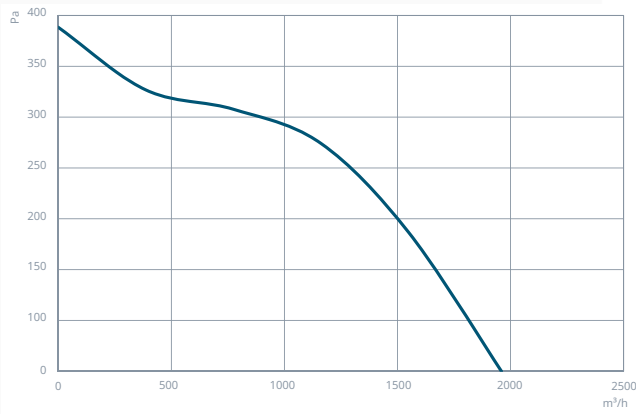



İLETİŞİM

.....

**Batı Sitesi Mah. 2310. Cad. No:50
Yenimahalle, Ankara, Türkiye**

Tel: +90 533 576 25 71

**info@nvsair.com
nvsair.com**