



NVSAIR

ventilation for life



ÜRÜN KATALOĞU

NHAF - Hücreli Aksiyel Fan



+90 533 576 25 71



www.nvsair.com



info@nvsair.com

► NHAF (Hücreli Aksiyel Fan)

Hücreli aksiyel fanlar kabin içinde olmaları ve kabinin çok yönlü montaja uygun olması nedeniyle zor montaj koşullarında kullanılabilir. Standart aç-kapa anahtarı ve kabin içi susturuculu olarak üretilmektedir.

Not: 5,50 kW ve üzeri cihazlarda Yıldız-Üçgen Pano veya Frekans Konvertörü KULLANILMALIDIR.



TANIM

DEĞER

MOTOR YALITIM SINIFI	F SINIFI
MOTOR KORUMA SINIFI	IP 54-IP 55
MOTOR VERİM SINIFI	IE2
GÖVDE MALZEMESİ	GALVANİZE SAC
GÖVDE KAPLAMASI	YOK
PERVANE MALZEMESİ	ALÜMİNYUM
GÖREV DÖNGÜSÜ	IEC Duty Cycle-S1
ÇALIŞMA SICAKLIĞI	-20 - +50 °C
STANDARTLAR	EN 60204-1



Motor Hava Akımının İçinde



Egzoz



Basınçlandırma



Kana Monte



MODEL	VOLTAJ (V)	FREKANS (Hz)	GÜÇ (kW)	DEVİR (rpm)	DEBİ (m ³ /h)	SES SEVİYESİ (dB(A))
NHAF 400-5-25	380	50	0,37	1.450	2.895	60
NHAF 450-5-25	380	50	0,55	1.456	4.180	61
NHAF 500-5-25	380	50	0,55	1.453	5.845	62
NHAF 560-5-25	380	50	0,75	1.466	8.150	63
NHAF 630-5-30	380	50	1,10	1.465	13.480	64
NHAF 710-5-30	380	50	1,50	1.472	19.210	65
NHAF 800-5-30	380	50	2,20	1.459	25.560	67
NHAF 800-5-35	380	50	3,00	1.463	30.940	69
NHAF 900-5-35	380	50	4,00	1.471	39.250	71
NHAF 900-5-40	380	50	5,50	1.472	44.635	73
NHAF 1000-5-40	380	50	7,50	1.478	54.570	73
NHAF 900-8-40	380	50	11,00	1.454	46.200	76
NHAF 1000-8-40	380	50	15,00	1.456	62.250	77
NHAF 1000-8-45	380	50	18,50	1.458	69.070	78
NHAF 1120-8-40	380	50	22,00	1.471	86.620	79
NHAF 1120-8-45	380	50	30,00	1.474	95.270	81

Değerler 0 Pa içindir

OPSİYONLAR



KORUMA TELİ



TAKOZ



YAY



PANO



+90 533 576 25 71



www.nvsair.com



info@nvsair.com

DİĞER OPSİYONLAR



Sıcaklık Dayanımlı
Motor Seçeneği



Alüminyum veya Plastik
Kanat Seçeneği



İstenilen Debi ve
Basınca Özel Üretim



Sistem Otomasyonu



5, 8, 12 ve 16 Kanat
Adedi Seçenekleri



Çift Devirli Motor
Seçeneği

TEKNİK RESİM

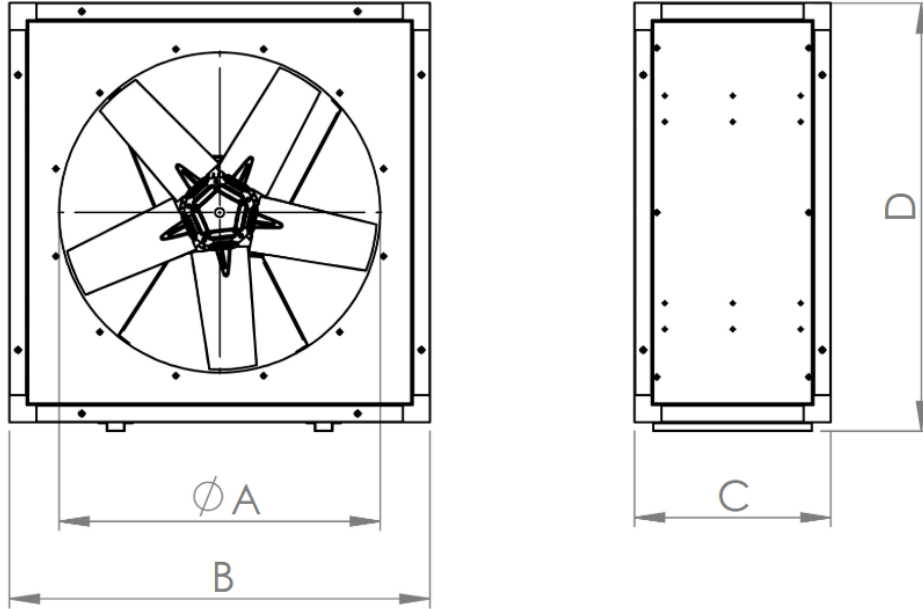

MODEL	A (mm)	B (mm)	C (mm)	D (mm)
NHAF 400	400	620	425	645
NHAF 450	450	670	425	695
NHAF 500	500	720	425	745
NHAF 560	560	780	425	805
NHAF 630	630	850	425	875
NHAF 710	710	930	425	955
NHAF 800	800	1020	425	1045
NHAF 900	900	1120	525	1145
NHAF 1000	1000	1220	525	1245
NHAF 1120	1120	1340	525	1365



+90 533 576 25 71



www.nvsair.com



info@nvsair.com

PERFORMANS EĞRİLERİ

NHAF 400-5-25

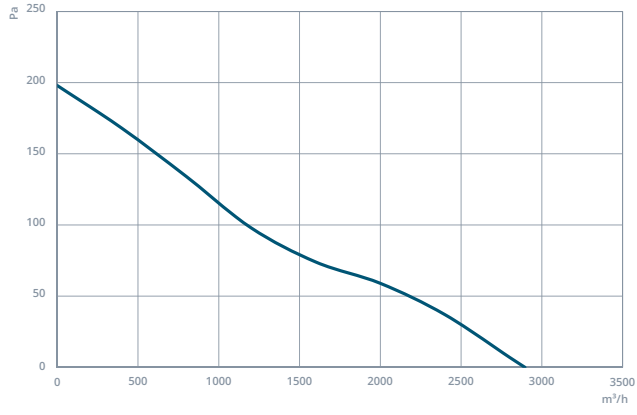

NHAF 450-5-25

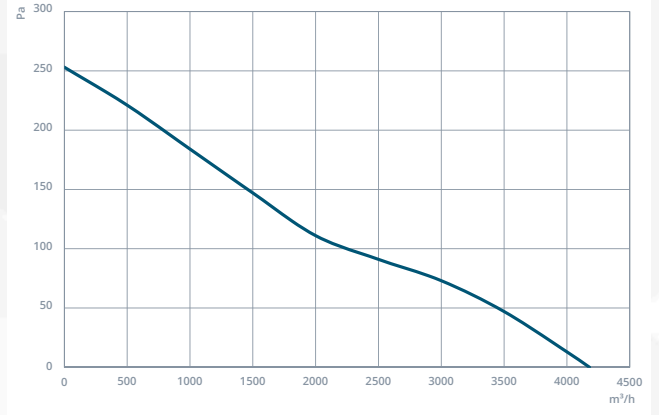

NHAF 500-5-25

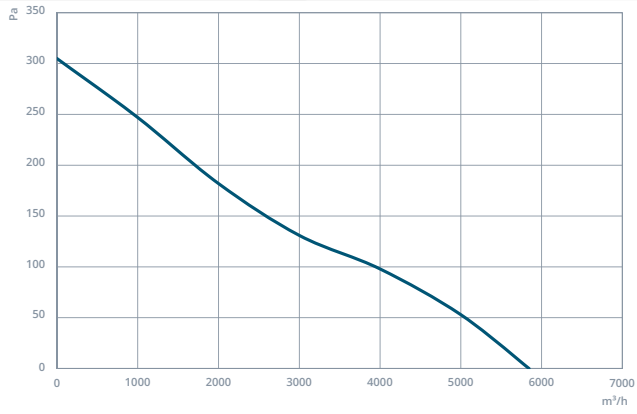

NHAF 560-5-25

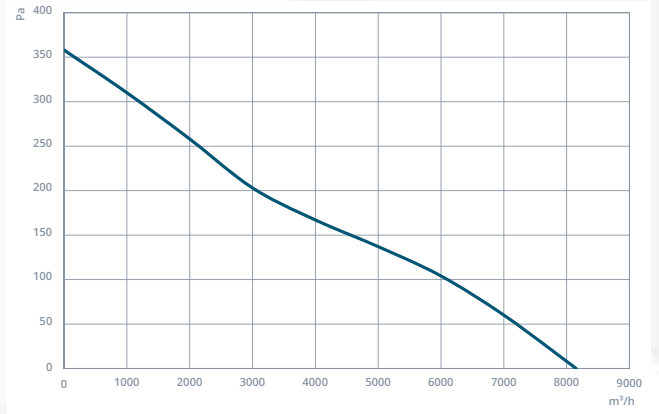

NHAF 630-5-30

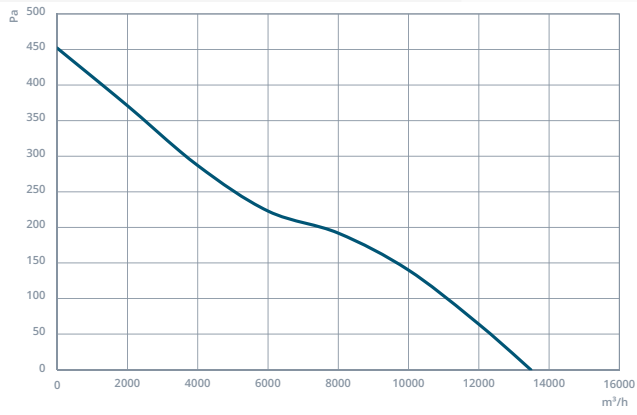

NHAF 710-5-30

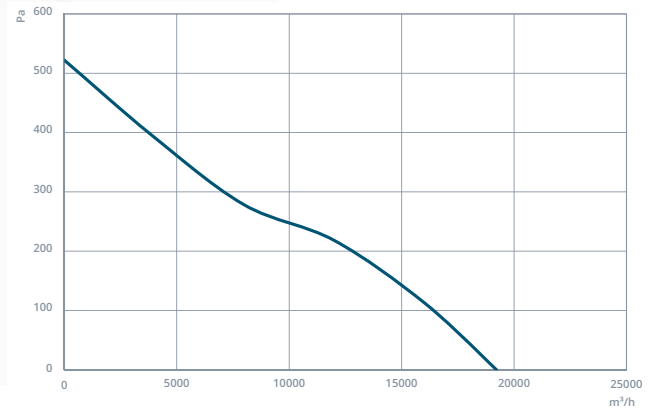

NHAF 800-5-30

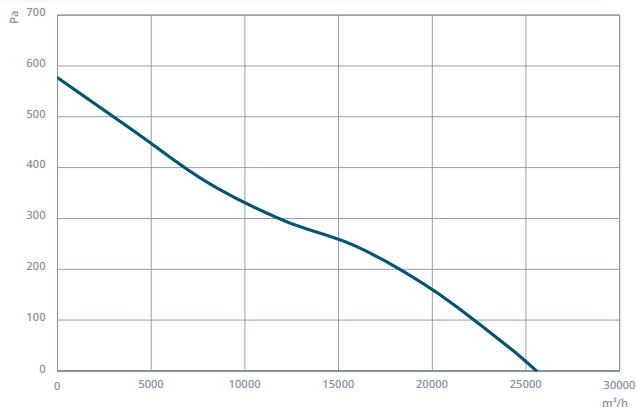

NHAF 800-5-35

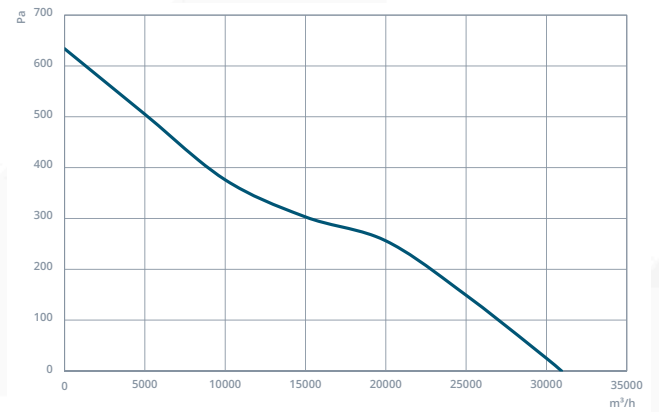

PERFORMANS EĞRİLERİ

NHAF 900-5-35

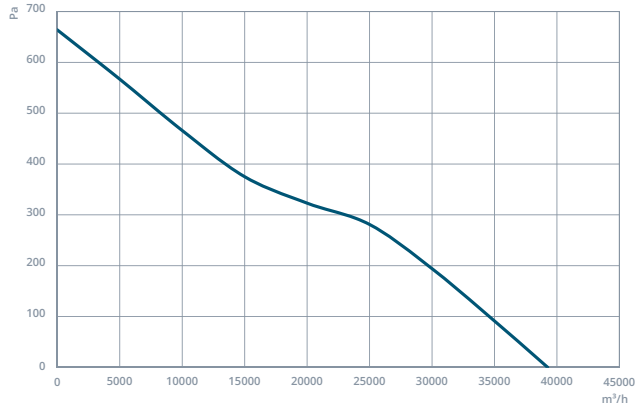

NHAF 900-5-40

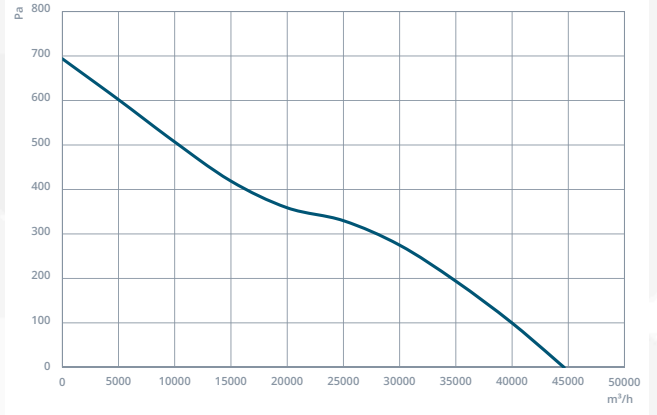

NHAF 1000-5-40

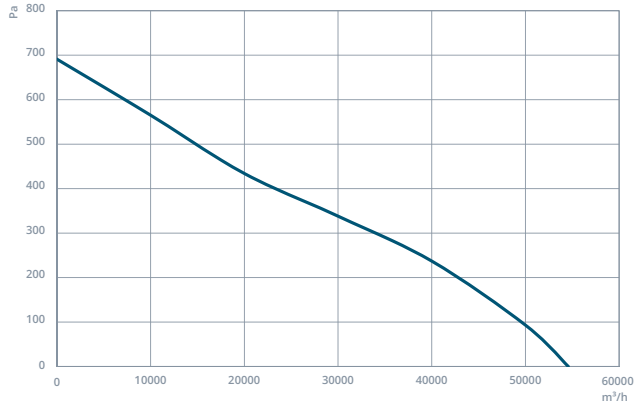

NHAF 900-8-40

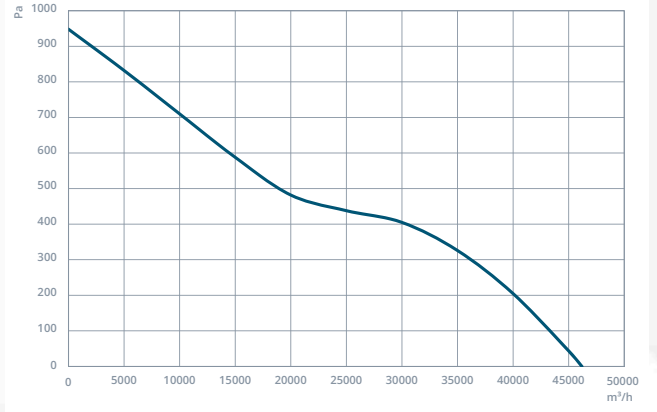

NHAF 1000-8-40

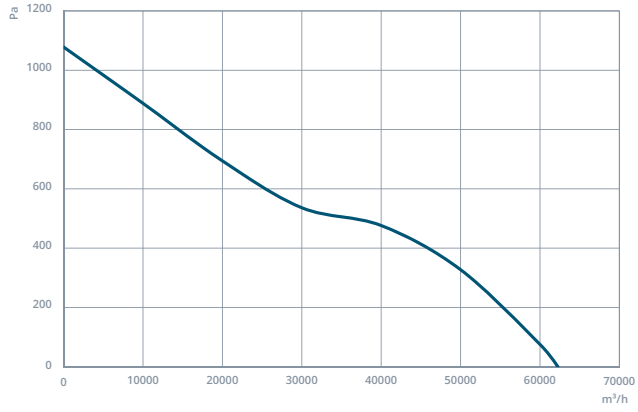

NHAF 1000-8-45

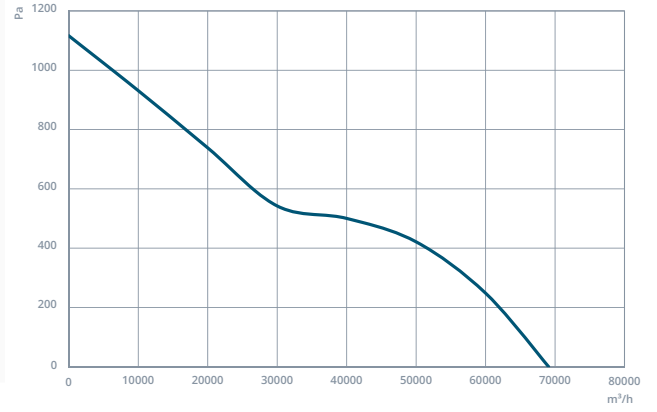

NHAF 1120-8-40

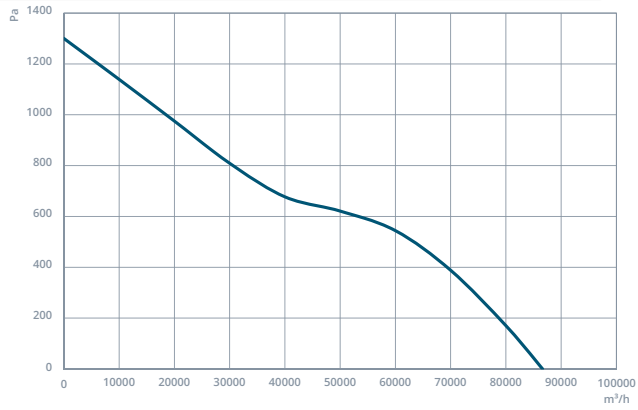

NHAF 1120-8-45

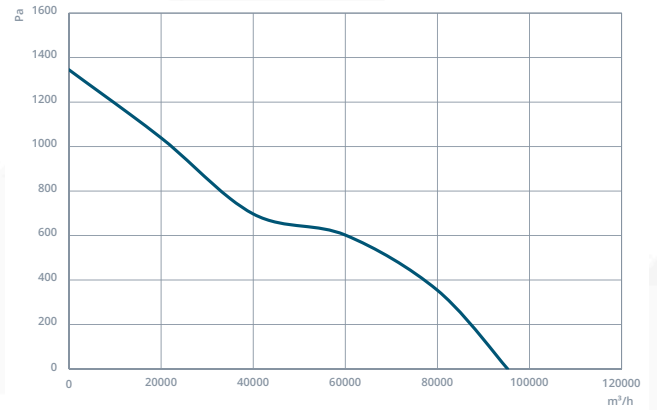



İLETİŞİM

.....

**Batı Sitesi Mah. 2310. Cad. No:50
Yenimahalle, Ankara, Türkiye**

Tel: +90 533 576 25 71

**info@nvsair.com
nvsair.com**