



NVSAIR

ventilation for life



ÜRÜN KATALOĞU

NDTF4 Aksiyel Duman Egzoz Fanı - F400



+90 533 576 25 71



www.nvsair.com



info@nvsair.com

► NDTF4 (Aksiyel Duman Egzoz Fanı - F400)

400 °C sıcaklığa iki saat boyunca dayanarak, Jet Fan'lar ile beraber otoparklarda yangın durumunda dumanın tahliyesini sağlamak için kullanılabilir.

Not: 5,50 kW ve üzeri cihazlarda Yıldız-Üçgen Pano veya Frekans Konvertörü KULLANILMALIDIR.



TANIM

DEĞER

MOTOR YALITIM SINIFI	H SINIFI
MOTOR KORUMA SINIFI	IP 54-IP 55
MOTOR VERİM SINIFI	IE1-IE2
GÖVDE MALZEMESİ	GALVANİZE SAC
GÖVDE KAPLAMASI	YOK
PERVANE MALZEMESİ	ALÜMİNYUM
GÖREV DÖNGÜSÜ	IEC Duty Cycle-S1
ÇALIŞMA SICAKLIĞI STANDARTLAR	-20 - +50 °C EN 60204-1



Motor Hava Akımının İçinde



Egzoz



F400 Fan



Kanala Monte

Türkiye



MODEL	VOLTAJ (V)	FREKANS (Hz)	GÜÇ (kW)	DEVİR (d/dk)	DEBİ (m ³ /h)	SES SEVİYESİ (dB(A))
NDTF4-450-5-25	380	50	0,55	1.456	4.180	69
NDTF4-500-5-25	380	50	0,55	1.453	5.845	72
NDTF4-560-5-25	380	50	0,75	1.466	8.150	75
NDTF4-630-5-30	380	50	1,10	1.465	13.480	80
NDTF4-710-5-30	380	50	1,50	1.472	19.210	83
NDTF4-800-5-30	380	50	2,20	1.459	25.560	85
NDTF4-800-5-35	380	50	3,00	1.463	30.940	89
NDTF4-900-5-35	380	50	4,00	1.471	39.250	90
NDTF4-900-5-40	380	50	5,50	1.472	44.635	93
NDTF4-1000-5-40	380	50	7,50	1.478	54.570	94
NDTF4-900-5-40	380	50	11,00	1.454	46.200	94
NDTF4-1000-5-40	380	50	15,00	1.456	62.250	97
NDTF4-1000-5-45	380	50	18,50	1.458	69.070	99
NDTF4-1120-5-40	380	50	22,00	1.471	86.620	100
NDTF4-1120-5-45	380	50	30,00	1.474	95.270	102

Değerler 0 Pa içindir

OPTIONS



KORUMA TELİ	MONTAJ	KARŞI FLANŞ	KONNEKTÖR	TAKOZ	YAY
ÖLÇÜ	ÖLÇÜ	ÖLÇÜ	ÖLÇÜ	ÖLÇÜ	ÖLÇÜ
315	315	315	315	315	315
355	355	355	355	355	355
400	400	400	400	400	400
450	450	450	450	450	450
500	500	500	500	500	500
560	560	560	560	560	560
630	630	630	630	630	630



+90 533 576 25 71



www.nvsair.com



info@nvsair.com

DİĞER OPSİYONLAR



İstenilen Debi ve
Basınca Özel Üretim



Çift Devirli Motor
Seçeneği



Sistem Otomasyonu



5, 8, 12 ve 16 Kanat
Adedi Seçenekleri

TEKNİK RESİM

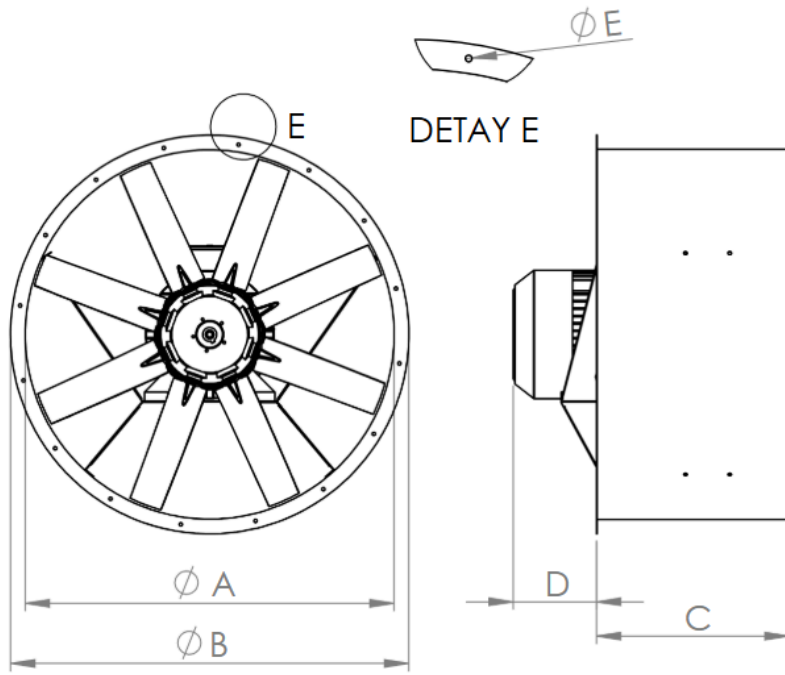

MODEL	A (mm)	B (mm)	C (mm)	D (mm)	E (mm)	N (Delik Sayısı)
NDTF4 450-5-25	450	530	320	50	11	8
NDTF4 500-5-25	500	580	320	70	11	8
NDTF4 560-5-25	560	640	320	60	11	12
NDTF4 630-5-30	630	710	420	45	11	12
NDTF4 710-5-30	710	790	420	25	11	12
NDTF4 800-5-30	800	880	420	50	11	16
NDTF4 800-5-35	800	880	420	50	11	16
NDTF4 900-5-35	900	980	520	0	11	16
NDTF4 900-5-40	900	980	520	35	11	16
NDTF4 1000-5-40	1000	1080	520	150	11	16
NDTF4 900-5-40	900	980	520	75	11	16
NDTF4 1000-5-40	1000	1080	520	180	11	16
NDTF4 1000-5-45	1000	1080	520	250	11	16
NDTF4 1120-5-40	1120	1200	520	250	11	16
NDTF4 1120-5-45	1120	1200	520	300	11	16



+90 533 576 25 71



www.nvsair.com



info@nvsair.com

DİĞER OPSİYONLAR

NDTF4 450-5-25

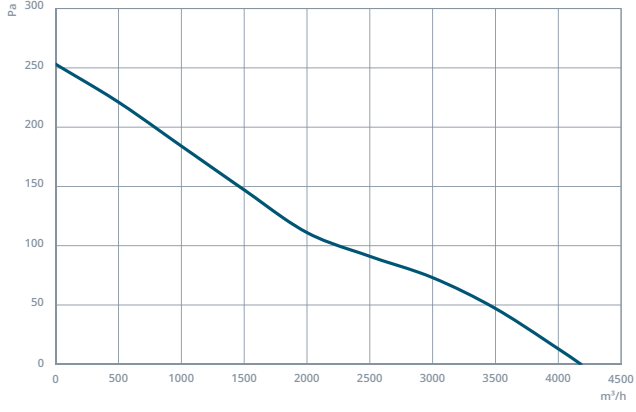

NDTF4 500-5-25

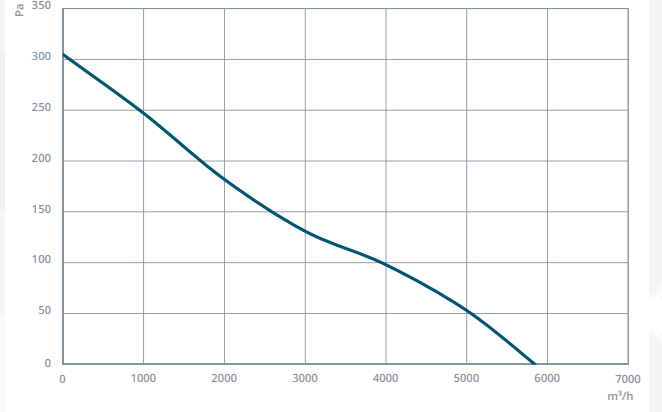

NDTF4 560-5-25

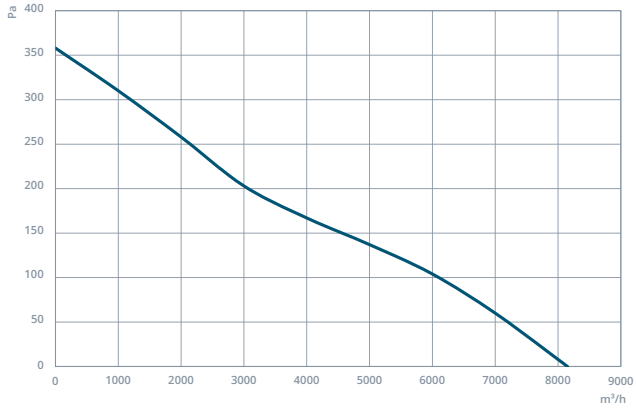

NDTF4 630-5-30

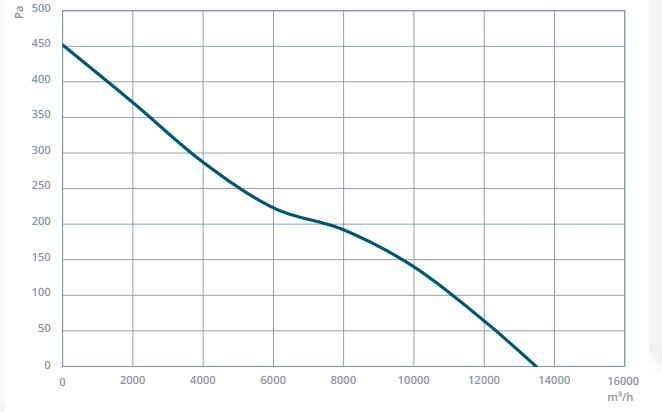

NDTF4 710-5-30

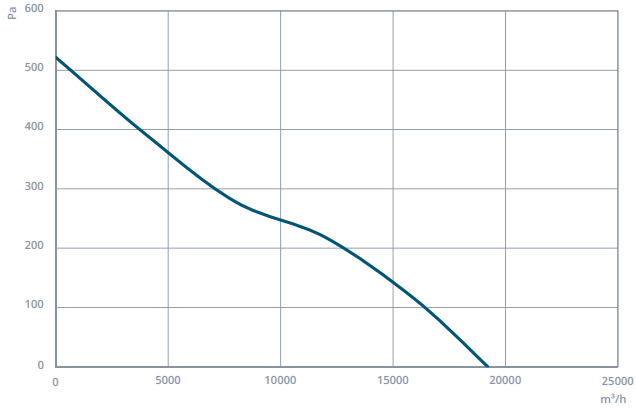

NDTF4 800-5-30

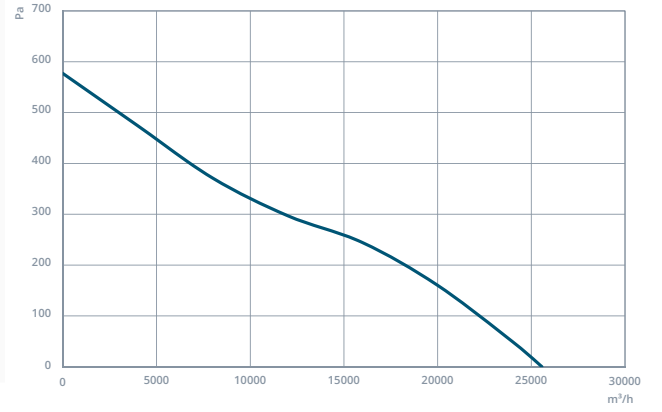

NDTF4 800-5-35

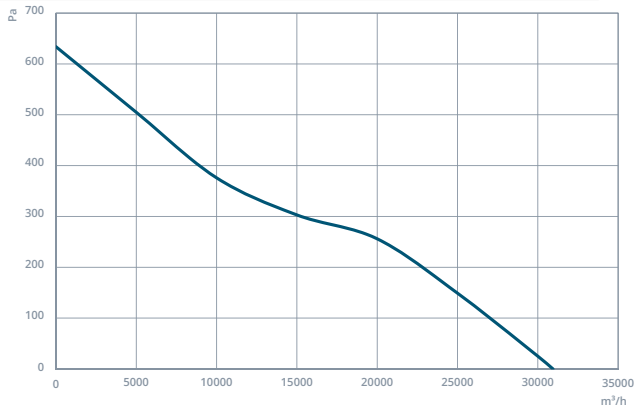

NDTF4 900-5-35

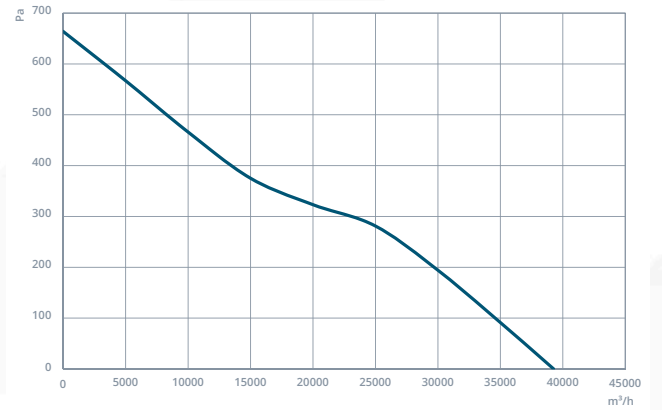

DİĞER OPSİYONLAR

NDTF4 900-5-40

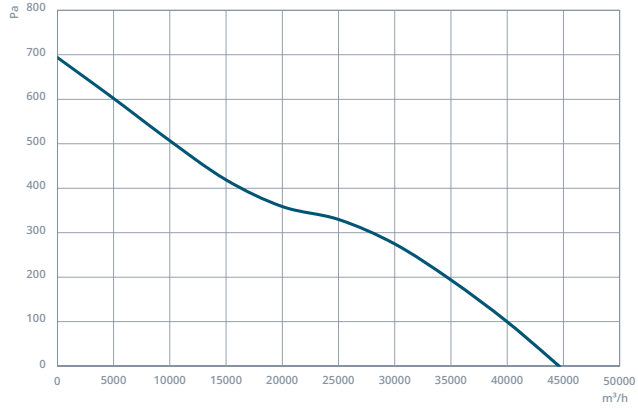

NDTF4 1000-5-40

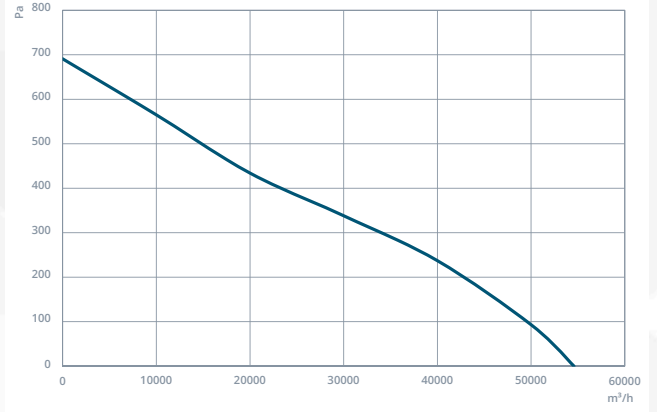

NDTF4 900-8-40

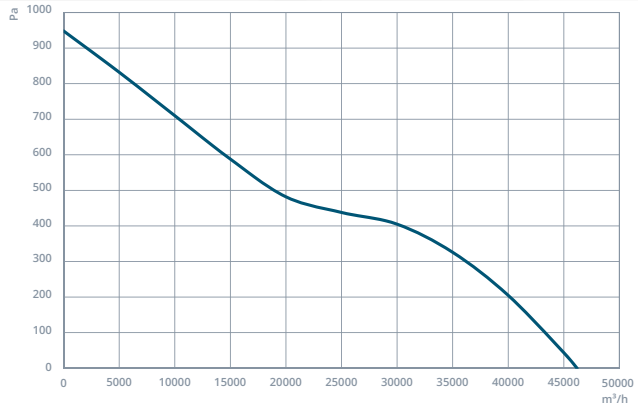

NDTF4 1000-8-40

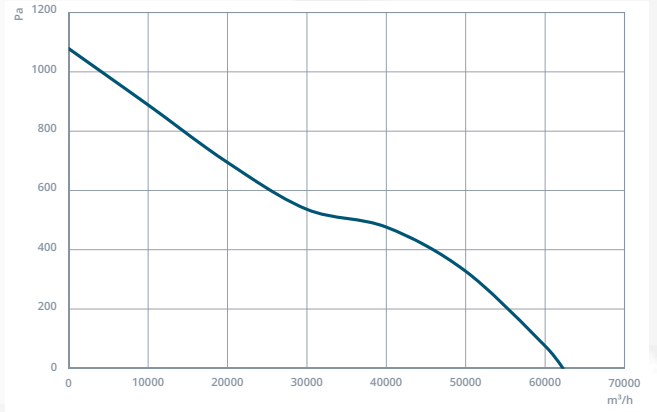

NDTF4 1000-8-40

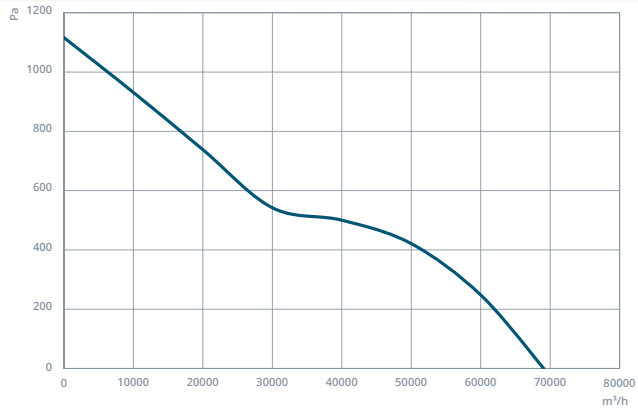

NDTF4 1120-8-40

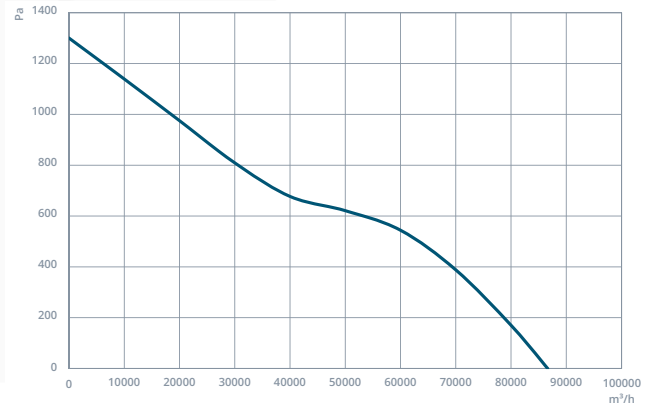

NDTF4 1120-8-45

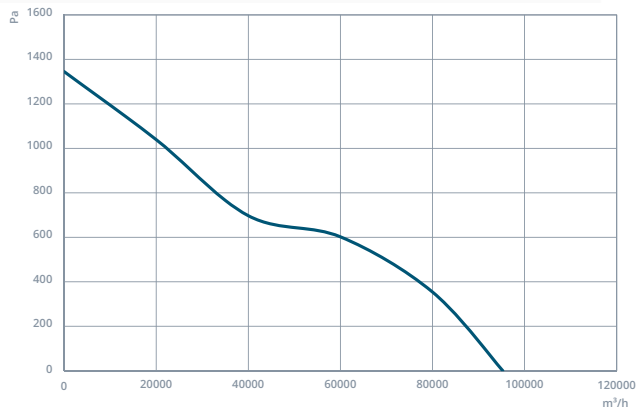



İLETİŞİM

.....

**Batı Sitesi Mah. 2310. Cad. No:50
Yenimahalle, Ankara, Türkiye**

Tel: +90 533 576 25 71

**info@nvsair.com
nvsair.com**