



NVSAIR

ventilation for life



ÜRÜN KATALOĞU

NDTF3 - F300 Aksiyel Duman Egzoz Fanı



+90 533 576 25 71



www.nvsair.com



info@nvsair.com

► NDTF3 (F300 Aksiyel Duman Egzoz Fanı)

300 °C sıcaklığa iki saat boyunca dayanarak, Jet Fan'lar ile beraber otoparklarda yangın durumunda dumanın tahliyesini sağlamak için kullanılabilir.

Not: 5,50 kW ve üzeri cihazlarda Yıldız-Üçgen Pano veya Frekans Konvertörü KULLANILMALIDIR.



TANIM

DEĞER

MOTOR YALITIM SINIFI	H SINIFI
MOTOR KORUMA SINIFI	IP 55
MOTOR VERİM SINIFI	IE3
GÖVDE MALZEMESİ	GALVANİZE SAC
GÖVDE KAPLAMASI	YOK
PERVANE MALZEMESİ	ALÜMİNYUM
GÖREV DÖNGÜSÜ	IEC Duty Cycle-S1
ÇALIŞMA SICAKLIĞI	-20 - +50 °C
STANDARTLAR	EN 60204-1



Motor Hava Akımının İçinde



Egzoz



300 °C 2H F300 Fan



Kanala Monte



MODEL	VOLTAJ (V)	FREKANS (Hz)	GÜÇ (kW)	DEVİR (d/dk)	DEBİ (m³/h)	SES SEVİYESİ (dB(A))
NDTF3 450-5-25	380	50	0,55	1.456	4.180	69
NDTF3 500-5-25	380	50	0,55	1.453	5.845	72
NDTF3 560-5-25	380	50	0,75	1.466	8.150	75
NDTF3 630-5-30	380	50	1,10	1.465	13.480	80
NDTF3 710-5-30	380	50	1,50	1.472	19.210	83
NDTF3 800-5-30	380	50	2,20	1.459	25.560	85
NDTF3 800-5-35	380	50	3,00	1.463	30.940	89
NDTF3 900-5-35	380	50	4,00	1.471	39.250	90
NDTF3 900-5-40	380	50	5,50	1.472	44.635	93
NDTF3 1000-5-40	380	50	7,50	1.478	54.570	94
NDTF3 900-5-40	380	50	11,00	1.454	46.200	94
NDTF3 1000-5-40	380	50	15,00	1.456	62.250	97
NDTF3 1000-5-45	380	50	18,50	1.458	69.070	99
NDTF3 1120-5-40	380	50	22,00	1.471	86.620	100
NDTF3 1120-5-45	380	50	30,00	1.474	95.270	102

Değerler 0 Pa içindir

OPSİYONLAR



KORUMA TELİ	MONTAJ	KARŞI FLANŞ	KONNEKTÖR	YAY
ÖLÇÜ	ÖLÇÜ	ÖLÇÜ	ÖLÇÜ	ÖLÇÜ
450	450	450	450	450
500	500	500	500	500
560	560	560	560	560
630	630	630	630	630
710	710	710	710	710
800	800	800	800	800
900	900	900	900	900
1000	1000	1000	1000	1000
1120	1120	1120	1120	1120



+90 533 576 25 71



www.nvsair.com



info@nvsair.com

DİĞER OPSİYONLAR



İstenilen Debi ve Basınca Özel Üretim



Çift Devirli Motor Seçeneği



Sistem Otomasyonu



5, 8, 12 ve 16 Kanat Adedi Seçenekleri

TEKNİK RESİM

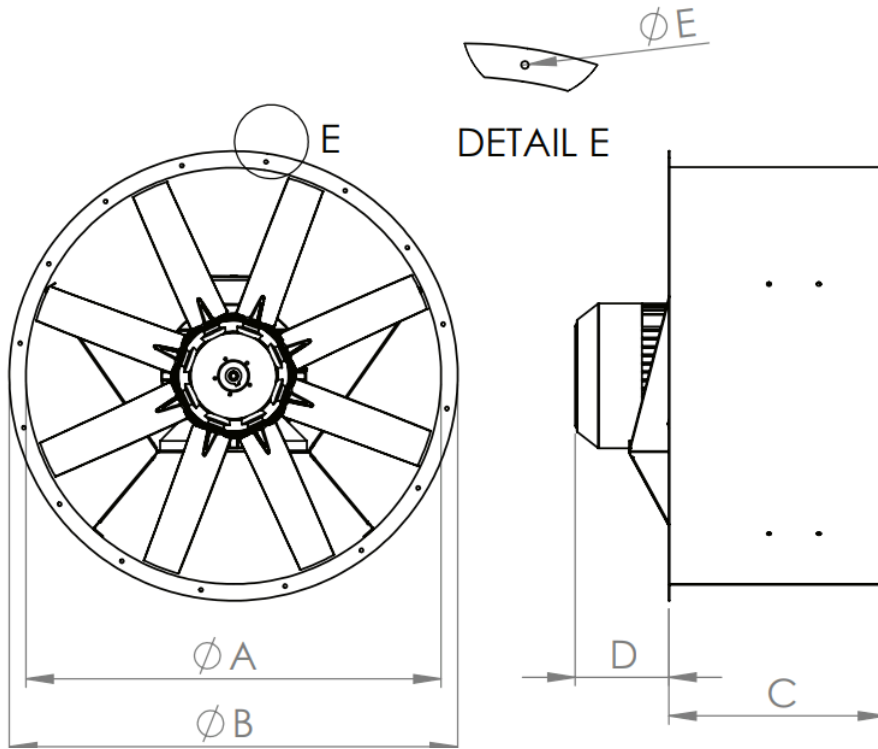

MODEL	A (mm)	B (mm)	C (mm)	D (mm)	E (mm)	N (Number of Holes)
NDTF3 450-5-25	450	530	320	50	11	8
NDTF3 500-5-25	500	580	320	70	11	8
NDTF3 560-5-25	560	640	320	60	11	12
NDTF3 630-5-30	630	710	420	45	11	12
NDTF3 710-5-30	710	790	420	25	11	12
NDTF3 800-5-30	800	880	420	50	11	16
NDTF3 800-5-35	800	880	420	50	11	16
NDTF3 900-5-35	900	980	520	0	11	16
NDTF3 900-5-40	900	980	520	35	11	16
NDTF3 1000-5-40	1000	1080	520	150	11	16
NDTF3 900-5-40	900	980	520	75	11	16
NDTF3 1000-5-40	1000	1080	520	180	11	16
NDTF3 1000-5-45	1000	1080	520	250	11	16
NDTF3 1120-5-40	1120	1200	520	250	11	16
NDTF3 1120-5-45	1120	1200	520	300	11	16



+90 533 576 25 71



www.nvsair.com



info@nvsair.com

PERFORMANS EGRILERI

NDTF3 450-5-25

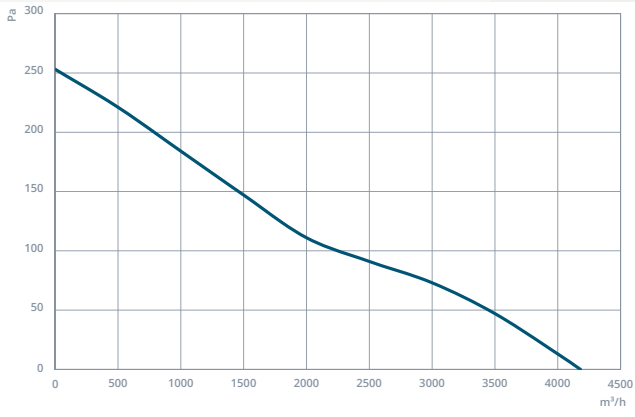

NDTF3 500-5-25

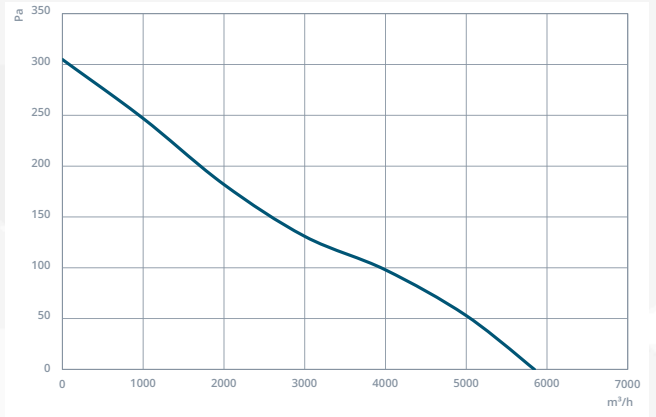

NDTF3 560-5-25

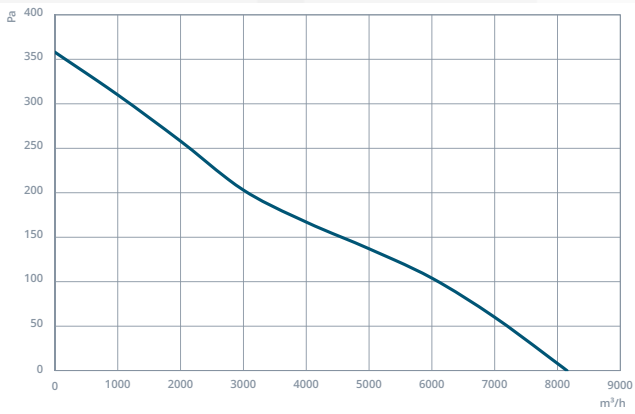

NDTF3 630-5-30

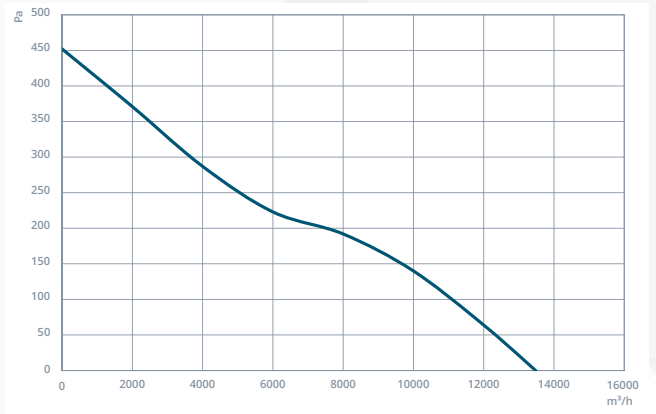

NDTF3 710-5-30

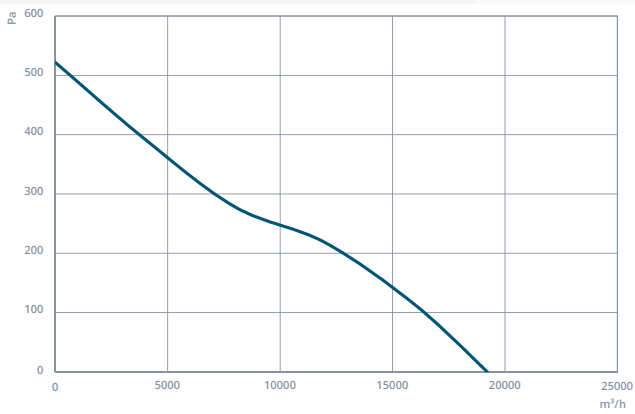

NDTF3 800-5-30

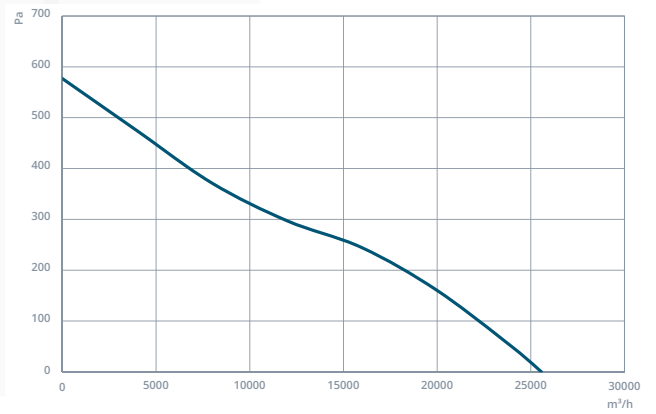

NDTF3 800-5-35

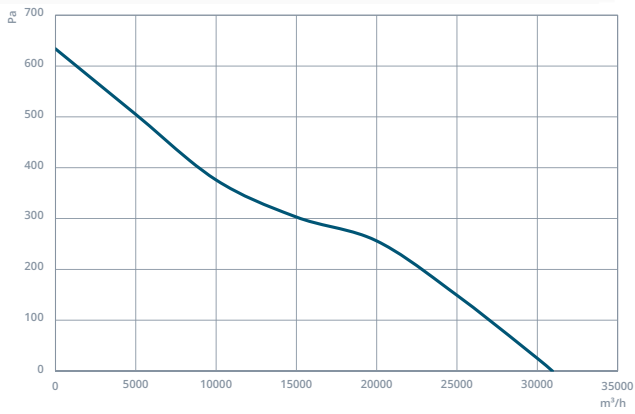

NDTF3 900-5-35

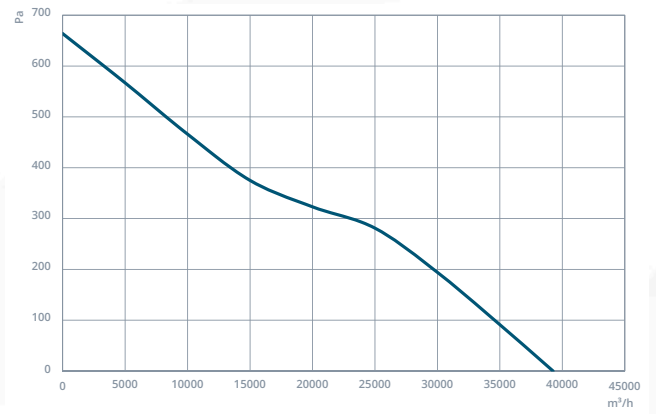

PERFORMANS EGRILERI

NDTF3 900-5-40

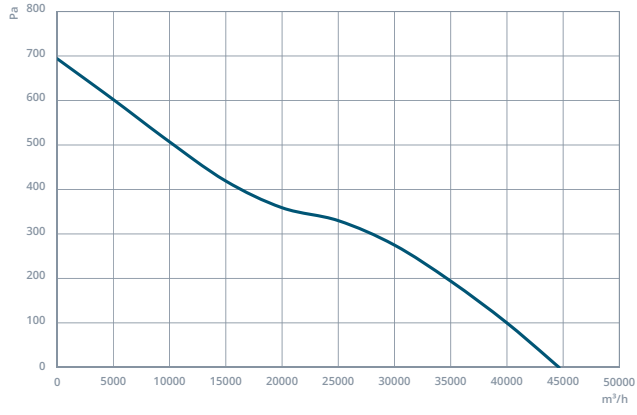

NDTF3 1000-5-40

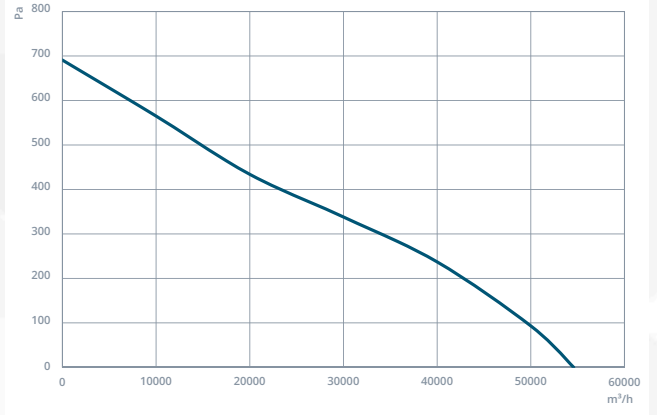

NDTF3 900-8-40

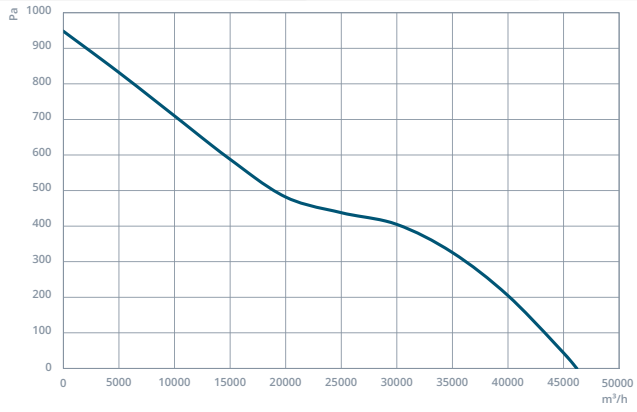

NDTF3 1000-8-40

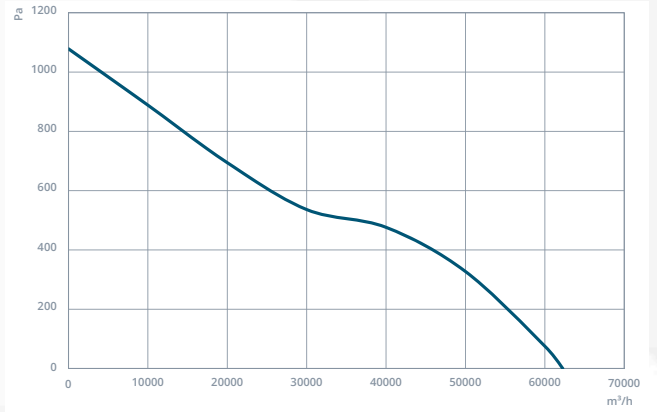

NDTF3 1000-8-45

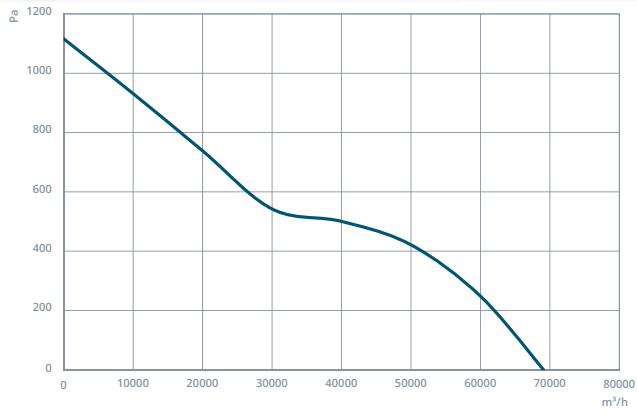

NDTF3 1120-8-40

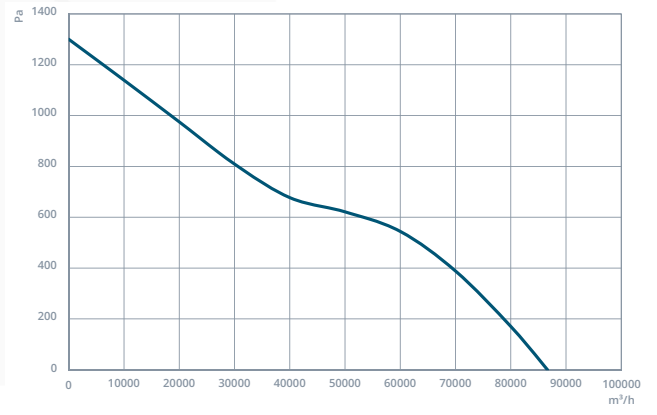

NDTF3 1120-8-45

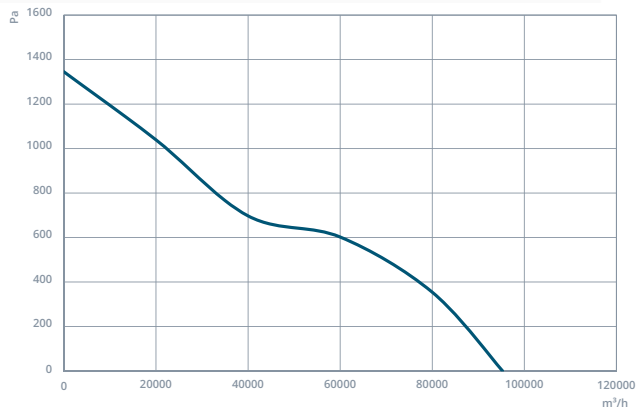



İLETİŞİM

.....

**Batı Sitesi Mah. 2310. Cad. No:50
Yenimahalle, Ankara, Türkiye**

Tel: +90 533 576 25 71

**info@nvsair.com
nvsair.com**