



NVSAIR

ventilation for life



ÜRÜN KATALOĞU

NDTF-SM Saklı Motorlu Aksiyel Fan



+90 533 576 25 71



www.nvsair.com



info@nvsair.com

► NDTF-SM (Saklı Motorlu Aksiyel Fan)

Saklı motorlu aksiyel fanlar motorun hava akımının dışında kalması gereken ve kayış-kasnak sistemli fanların kullanılmayacağı durumlarda tercih edilir. Sürekli sıcaklık altında çalışmak zorunda olan fanlar için opsiyonel olarak NDTF-SM fanlar ile motor soğutması yapılabilir.

Not: 5,50 kW ve üzeri cihazlarda Yıldız-Üçgen Pano veya Frekans Konvertörü KULLANILMALIDIR.



TANIM

DEĞER

| | |
|-------------------------------|----------------------------|
| MOTOR YALITIM SINIFI | F SINIFI |
| MOTOR KORUMA SINIFI | IP 54-IP 55 |
| MOTOR VERİM SINIFI | IE2 |
| GÖVDE MALZEMESİ | GALVANİZE SAC |
| GÖVDE KAPLAMASI | YOK |
| PERVANE MALZEMESİ | ALÜMİNYUM |
| GÖREV DÖNGÜSÜ | IEC Duty Cycle-S1 |
| ÇALIŞMA SICAKLIĞI STANDARTLAR | -20 - +50 °C EN 60204-1 |



Motor Hava Akımının Dışında



Egzoz



120 °C Sürekli Kullanım



Kana Monte

TÜRKİYE

ERC

TSEK

TSE

TRAFİK

CE

| MODEL | VOLTAJ (V) | FREKANS (Hz) | GÜÇ (kW) | DEVİR (rpm) | DEBİ (m ³ /h) | SES SEVİYESİ (dB(A)) |
|-------------------|------------|--------------|----------|-------------|--------------------------|----------------------|
| NDTF-SM 710 | 380 | 50 | 1,50 | 1.472 | 17.000 | 83 |
| NDTF-SM 800-5-30 | 380 | 50 | 2,20 | 1.459 | 22.250 | 85 |
| NDTF-SM 800-5-35 | 380 | 50 | 3,00 | 1.463 | 26.940 | 89 |
| NDTF-SM 900-5-35 | 380 | 50 | 4,00 | 1.471 | 34.150 | 90 |
| NDTF-SM 900-5-40 | 380 | 50 | 5,50 | 1.472 | 40.000 | 93 |
| NDTF-SM 1000-5-40 | 380 | 50 | 7,50 | 1.478 | 49.570 | 94 |
| NDTF-SM 900-8-40 | 380 | 50 | 11,00 | 1.454 | 43.200 | 94 |
| NDTF-SM 1000-8-40 | 380 | 50 | 15,00 | 1.456 | 58.850 | 97 |
| NDTF-SM 1000-8-45 | 380 | 50 | 18,50 | 1.458 | 66.070 | 99 |
| NDTF-SM 1120-8-40 | 380 | 50 | 22,00 | 1.471 | 84.620 | 100 |
| NDTF-SM 1120-8-45 | 380 | 50 | 30,00 | 1.474 | 92.270 | 102 |

Değerler 0 Pa içindir

OPTIONS



KORUMA TELİ

MONTAJ AYAĞI

KARŞI FLANŞ

KONNEKTÖR

TAKOZ

YAY

PANO



+90 533 576 25 71



www.nvsair.com



info@nvsair.com

DİĞER OPSİYONLAR



İstenilen Renkte
Elektro-Statik Toz Boya



Alüminyum veya Plastik
Kanat Seçeneği



İstenilen Debi ve
Basınca Özel Üretim



Sistem Otomasyonu



5, 8, 12 ve 16 Kanat
Adedi Seçenekleri



Çift Devirli Motor
Seçeneği

TEKNİK RESİM

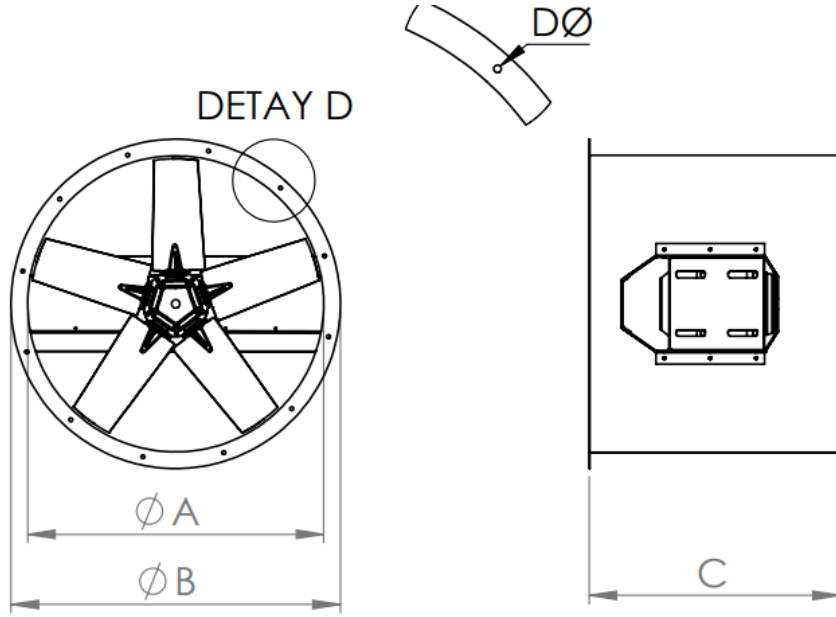

| MODEL | A (mm) | B (mm) | C (mm) | D (mm) | N |
|--------------|--------|--------|--------|--------|----|
| NDTF-SM 710 | 710 | 790 | 600 | 11 | 12 |
| NDTF-SM 800 | 800 | 880 | 650 | 11 | 16 |
| NDTF-SM 900 | 900 | 980 | 700 | 11 | 16 |
| NDTF-SM 1000 | 1000 | 1080 | 740 | 11 | 16 |
| NDTF-SM 1120 | 1120 | 1200 | 800 | 11 | 16 |

N: Delik Sayısı



+90 533 576 25 71



www.nvsair.com



info@nvsair.com

PERFORMANS EĞRİLERİ

NDTF-SM 710-5-30

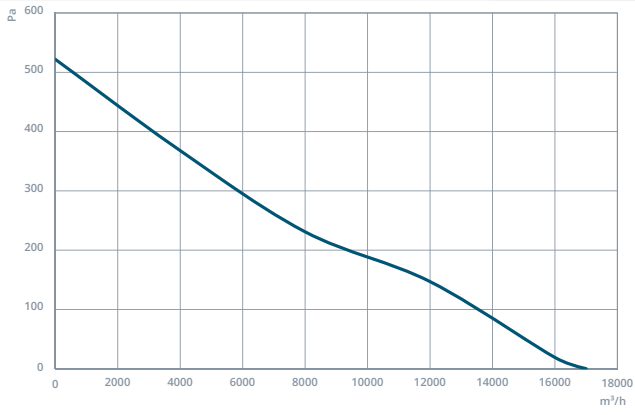

NDTF-SM 800-5-30

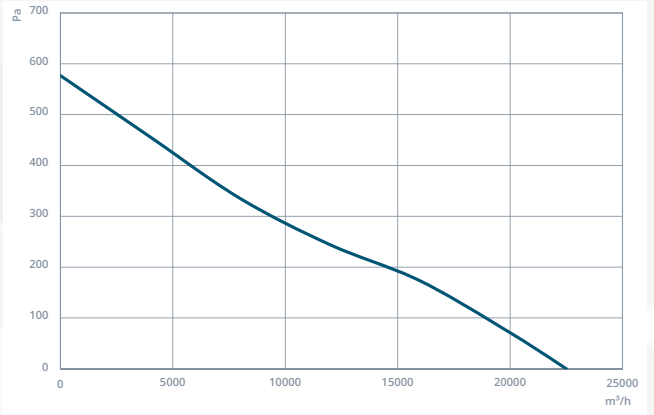

NDTF-SM 800-5-35

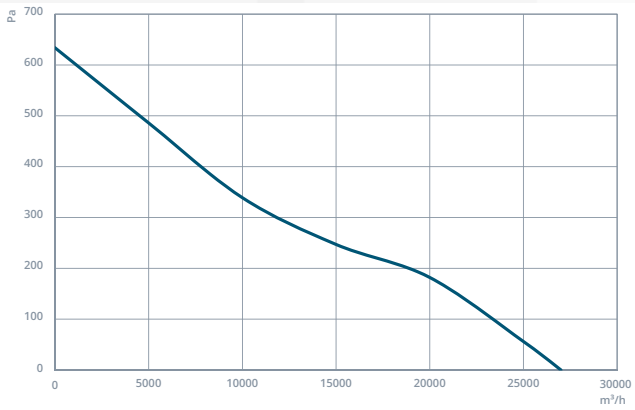

NDTF-SM 900-5-35

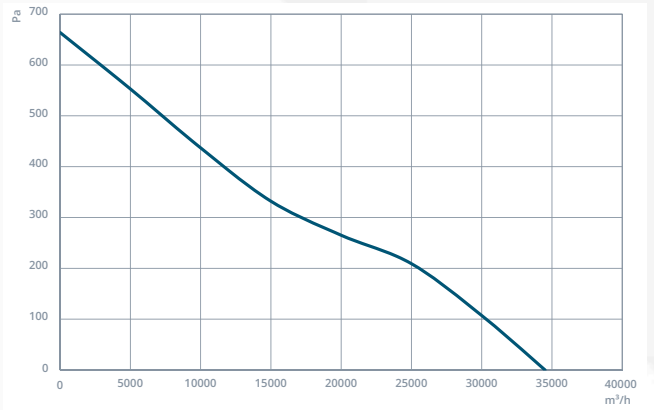

NDTF-SM 900-5-40

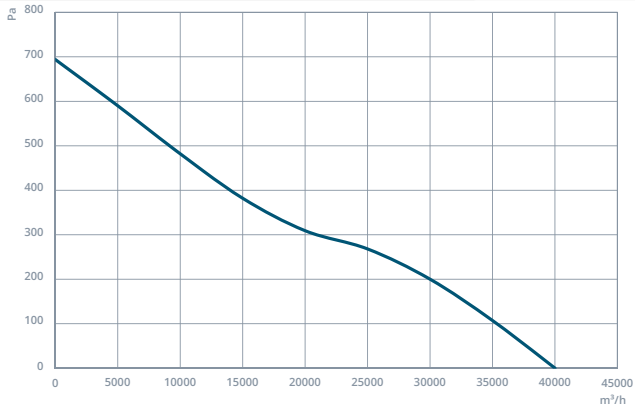

NDTF-SM 1000-5-40

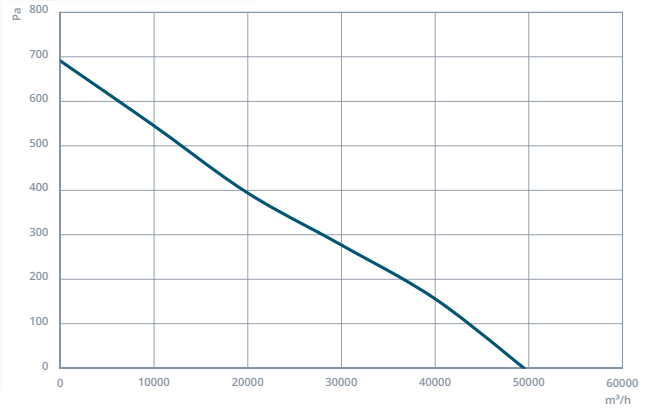

NDTF-SM 900-8-40

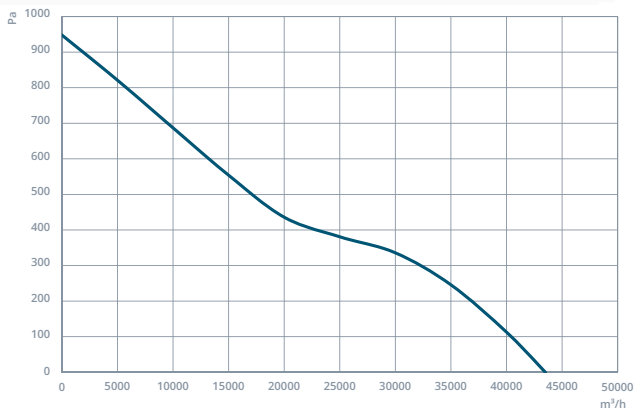

NDTF-SM 1000-8-40

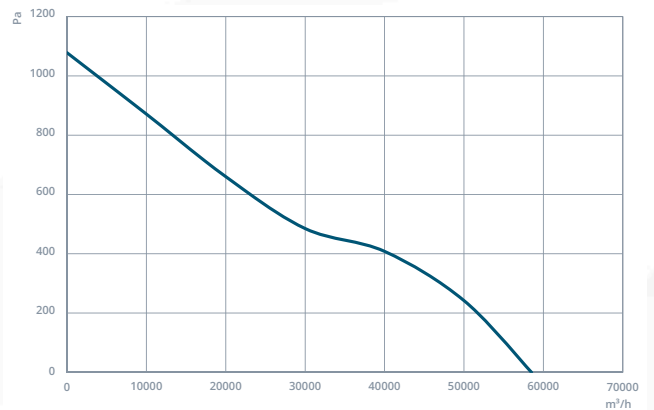

PERFORMANS EĞRİLERİ

NDTF-SM 1000-8-45

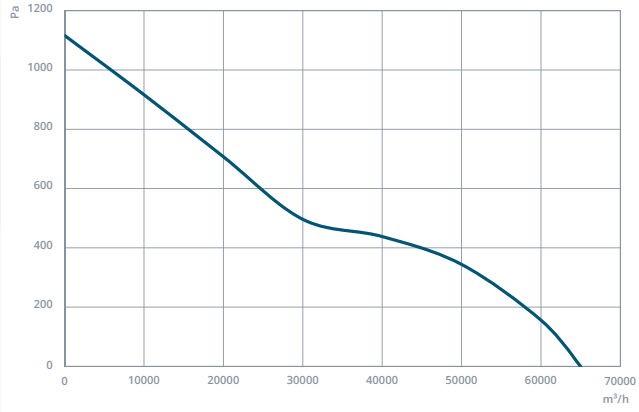

NDTF-SM 1120-8-40

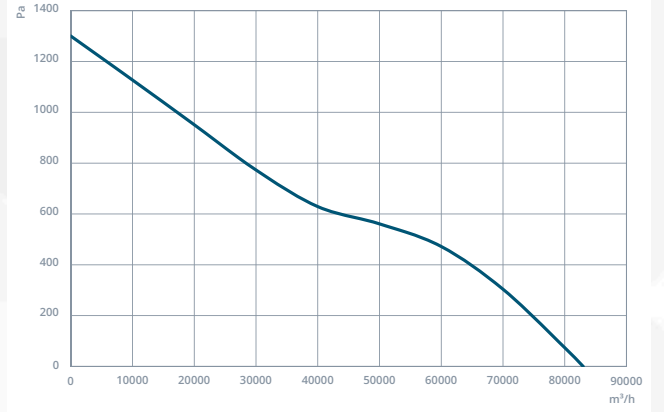

NDTF-SM 1120-8-45

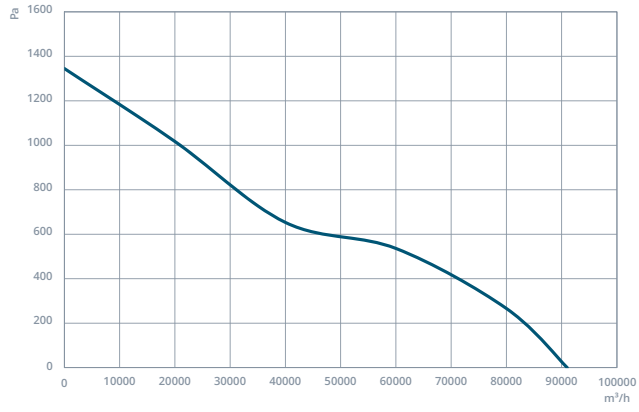



İLETİŞİM

.....

**Batı Sitesi Mah. 2310. Cad. No:50
Yenimahalle, Ankara, Türkiye**

Tel: +90 533 576 25 71

**info@nvsair.com
nvsair.com**