



NVSAIR

ventilation for life



ÜRÜN KATALOĞU

NDTF-DM Dıştan Motorlu
Kasnaklı Aksiyel Fan



+90 533 576 25 71



www.nvsair.com



info@nvsair.com

► NDTF-DM (Dıştan Motorlu Kasnaklı Aksiyel Fan)

Kayış-Kasnaklı Dıştan Motorlu Aksiyel Fanlar motorun hava akımının içinde kalmaması gereken durumlarda kullanılır. Kayış-kasnak sistemi sayesinde üretim aşamasında müşteri isteği doğrultusunda motor devirinin dışında bir devire sabitlenebilir. Montaj ayağı ürünle beraber standart olarak teslim edilmektedir.

Not: 5,50 kW ve üzeri cihazlarda Yıldız-Üçgen Pano veya Frekans Konvertörü KULLANILMALIDIR.



TANIM

DEĞER

MOTOR YALITIM SINIFI	F SINIFI
MOTOR KORUMA SINIFI	IP 54-IP 55
MOTOR VERİM SINIFI	IE2
GÖVDE MALZEMESİ	GALVANİZE SAC
GÖVDE KAPLAMASI	YOK
PERVANE MALZEMESİ	ALÜMİNYUM
GÖREV DÖNGÜSÜ	IEC Duty Cycle-S1
ÇALIŞMA SICAKLIĞI	-20 - +50 °C
STANDARTLAR	EN 60204-1



Motor Hava Akımının Dışında



Egzoz



Basınçlandırma



KANALA MONTE

TÜRKİY

ERC

TSEK

TSE

CE

MODEL	VOLTAJ (V)	FREKANS (Hz)	GÜÇ (kW)	DEVİR (rpm)	DEBİ (m³/h)	SES SEVİYESİ (dB(A))
NDTF-DM400-5-25	380	50	0,37	1.450	2.895	66
NDTF-DM450-5-25	380	50	0,55	1.456	4.180	69
NDTF-DM500-5-25	380	50	0,55	1.453	5.845	72
NDTF-DM560-5-25	380	50	0,75	1.466	8.150	75
NDTF-DM630-5-30	380	50	1,10	1.465	13.480	80
NDTF-DM710-5-30	380	50	1,50	1.472	19.210	83
NDTF-DM800-5-30	380	50	2,20	1.459	25.560	85
NDTF-DM800-5-35	380	50	3,00	1.463	30.940	89
NDTF-DM900-5-35	380	50	4,00	1.471	39.250	90
NDTF-DM900-5-40	380	50	5,50	1.472	44.635	93
NDTF-DM1000-5-40	380	50	7,50	1.478	54.570	94
NDTF-DM900-5-40	380	50	11,00	1.454	46.200	94
NDTF-DM1000-5-40	380	50	15,00	1.456	62.250	97
NDTF-DM1000-5-45	380	50	18,50	1.458	69.070	99
NDTF-DM1120-5-40	380	50	22,00	1.471	86.620	100
NDTF-DM1120-5-45	380	50	30,00	1.474	95.270	102

Değerler 0 Pa içindir

OPSİYONLAR



KORUMA TELİ



KARŞI FLANŞ



KONNEKTÖR



TAKOZ



YAY



PANEL



+90 533 576 25 71



www.nvsair.com



info@nvsair.com

DiĐER OPSİYONLAR



İstenilen Renkte
Elektro-Statik Toz Boya



Alüminyum veya Plastik
Kanat SeçeneĐi



İstenilen Debi ve
Basınca Özel Üretim



Sistem Otomasyonu



5, 8, 12 ve 16 Kanat
Adedi Seçenekleri



Çift Devirli Motor
SeçeneĐi

TEKNİK RESİM

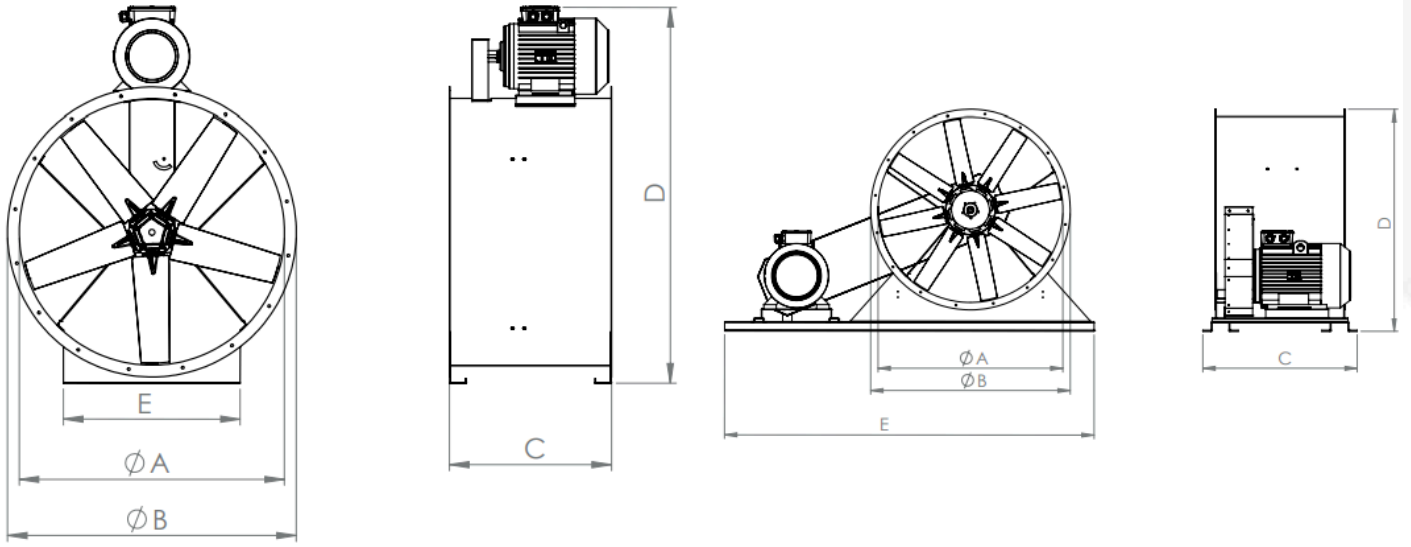

MODEL	A (mm)	B (mm)	C (mm)	D (mm)	E (mm)
NDTF-DM 400	400	480	380	660	300
NDTF-DM 450	450	530	400	720	330
NDTF-DM 500	500	580	400	770	360
NDTF-DM 560	560	640	430	840	400
NDTF-DM 630	630	710	500	925	440
NDTF-DM 710	710	790	500	1005	480
NDTF-DM 800	800	880	500	1110	520
NDTF-DM 900	900	980	740	1360	560
NDTF-DM 1000	1000	1080	740	1470	600

MODEL	A (mm)	B (mm)	C (mm)	D (mm)	E (mm)
NDTF-DM1000	1000	1080	836	1195	2000
NDTF-DM1120	1120	1200	956	1315	2000

NDTF-DM 1000-8-45 ve üstündeki modellerde motor fan gövdesinin üstüne konulamadığı için platform üstüne monte edilir.



+90 533 576 25 71



www.nvsair.com



info@nvsair.com

DİĞER OPSİYONLAR

NDTF-DM 400

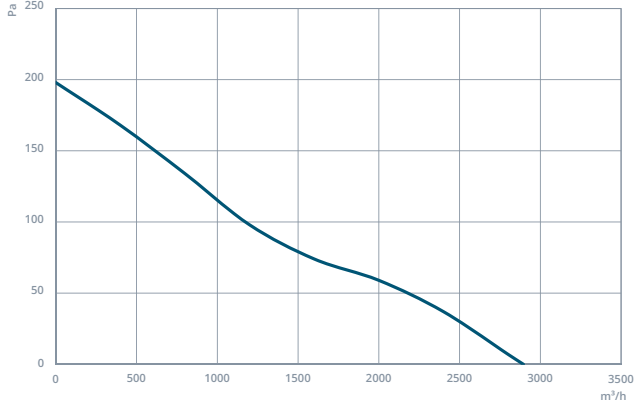

NDTF-DM 450

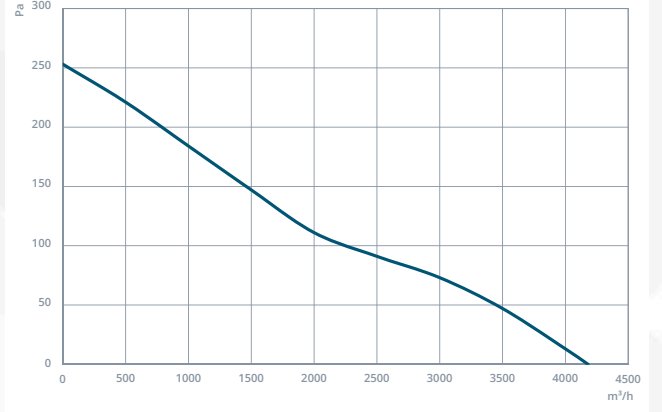

NDTF-DM 500

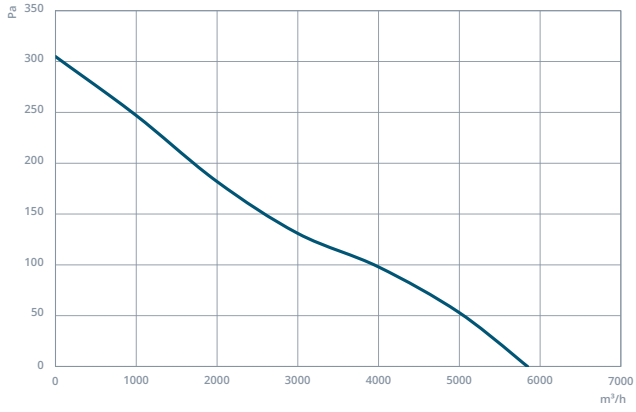

NDTF-DM 560

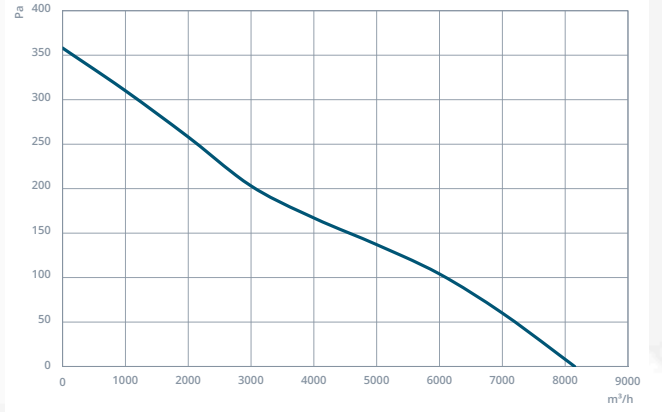

NDTF-DM 630

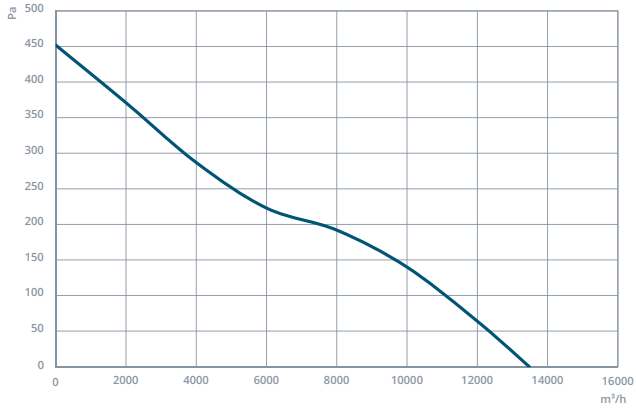

NDTF-DM 710

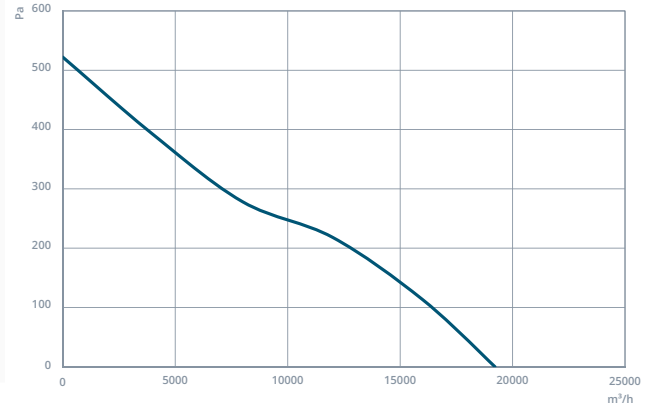

NDTF-DM 800

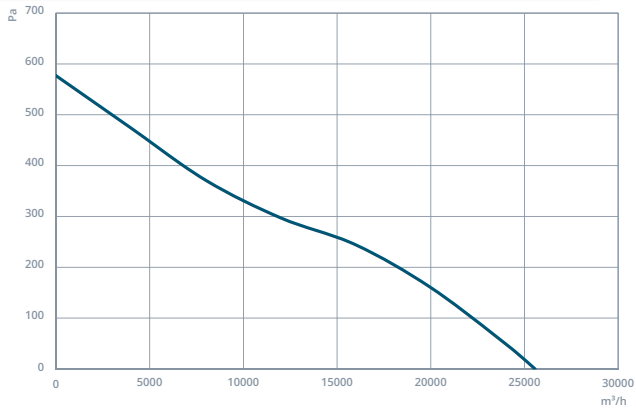

NDTF-DM 800

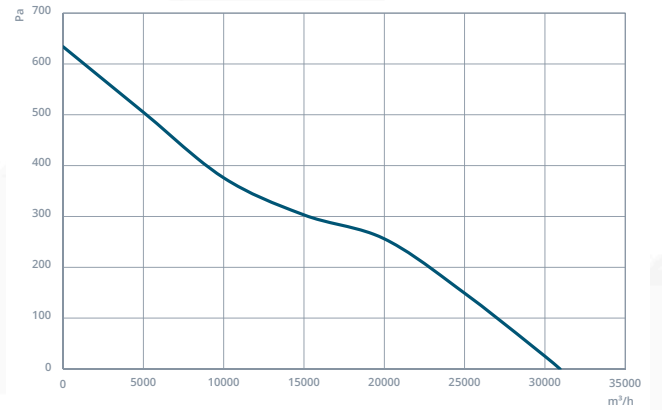

DİĞER OPSİYONLAR

NDTF-DM 900

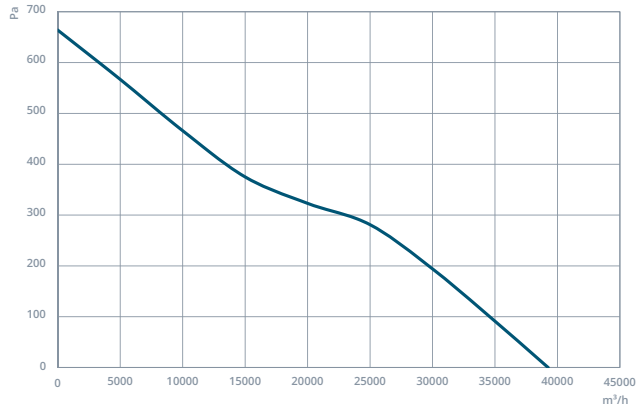

NDTF-DM 900

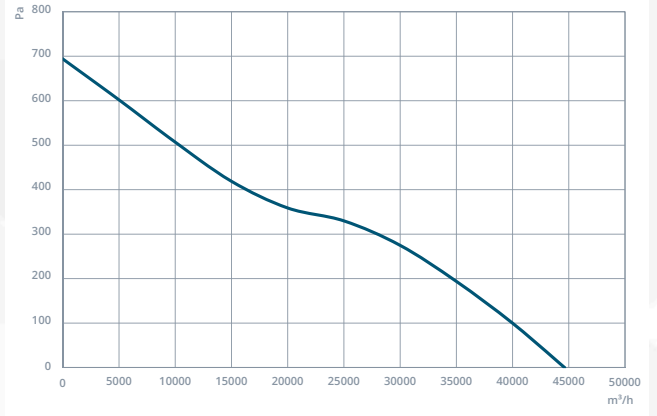

NDTF-DM 1000

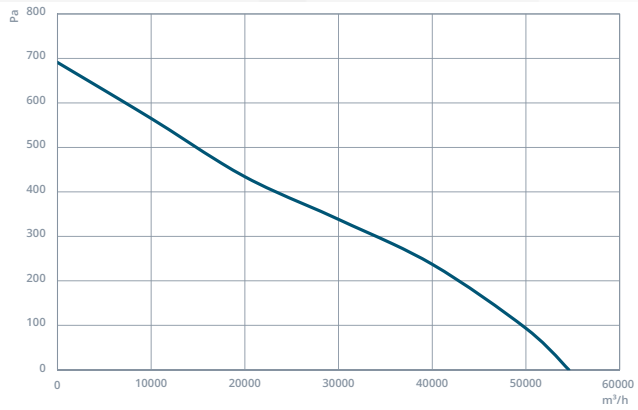

NDTF-DM 900

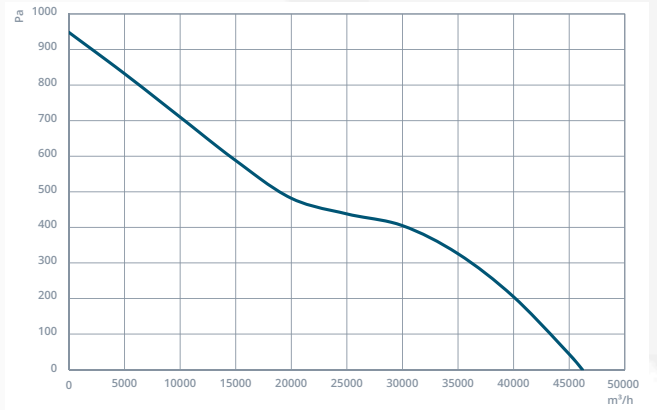

NDTF-DM 1000

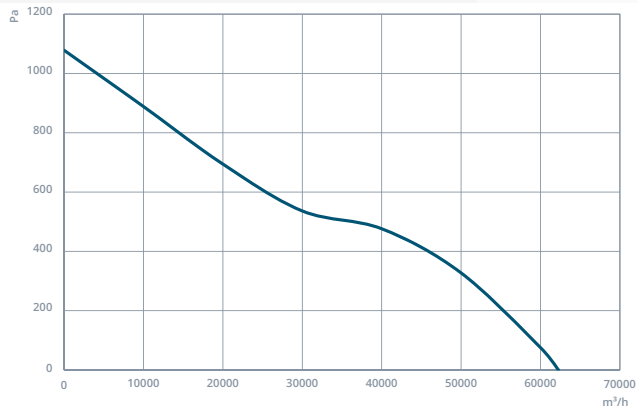

NDTF-DM 1000

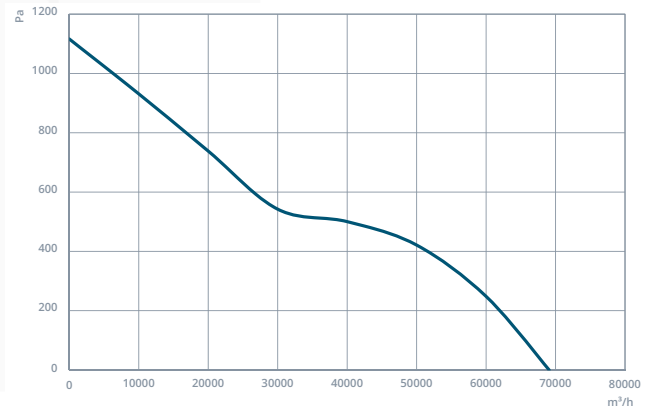

NDTF-DM 1120

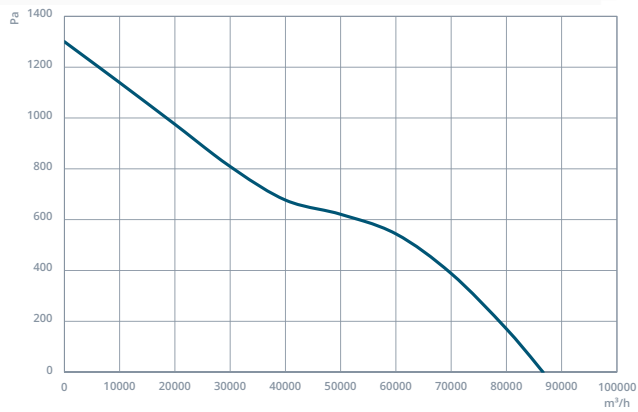

NDTF-DM 1120

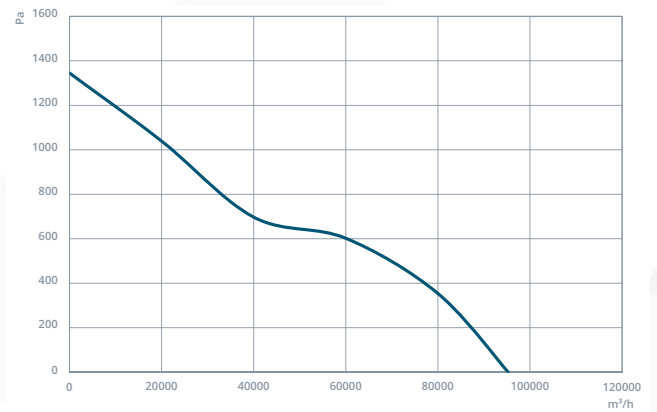



İLETİŞİM

.....

**Batı Sitesi Mah. 2310. Cad. No:50
Yenimahalle, Ankara, Türkiye**

Tel: +90 533 576 25 71

**info@nvsair.com
nvsair.com**