



NVSAIR

ventilation for life



ÜRÜN KATALOĞU

NABF - Aksiyel Basınçlandırma Fanı



+90 533 576 25 71



www.nvsair.com



info@nvsair.com

► NABF (Aksiyel Basınçlandırma Fanı)

Aksiyel basınçlandırma fanları merdiven, asansör boşluğu vb. gibi basınçlandırma ihtiyaçlarını karşılamak için kullanılabilir. Kanallı sistemlerle yüksek debi ihtiyacı olan projelerde kullanılabilir.

Not: 5,50 kW ve üzeri cihazlarda Yıldız-Üçgen Pano veya Frekans Konvertörü KULLANILMALIDIR.



TANIM

DEĞER

MOTOR YALITIM SINIFI	F SINIFI
MOTOR KORUMA SINIFI	IP 55
MOTOR VERİM SINIFI	IE3
GÖVDE MALZEMESİ	GALVANİZE SAC
GÖVDE KAPLAMASI	YOK
PERVANE MALZEMESİ	ALÜMİNYUM
GÖREV DÖNGÜSÜ	IEC Duty Cycle-S1
ÇALIŞMA SICAKLIĞI	-20 - +50 °C
STANDARTLAR	EN 60204-1



Motor Hava Akımının İçinde



Egzoz



Basınçlandırma



Kana Monte



MODEL	VOLTAJ (V)	FREKANS (Hz)	GÜÇ (kW)	DEVİR (rpm)	DEBİ (m³/h)	SES SEVİYESİ (dB(A))
NABF 400-5-25	380	50	0,37	1.450	2.895	66
NABF 450-5-25	380	50	0,55	1.456	4.180	69
NABF 500-5-25	380	50	0,55	1.453	5.845	72
NABF 560-5-25	380	50	0,75	1.466	8.150	75
NABF 630-5-30	380	50	1,10	1.465	13.480	80
NABF 710-5-30	380	50	1,50	1.472	19.210	83
NABF 800-5-30	380	50	2,20	1.459	25.560	85
NABF 800-5-35	380	50	3,00	1.463	30.940	89
NABF 900-5-35	380	50	4,00	1.471	39.250	90
NABF 900-5-40	380	50	5,50	1.472	44.635	93
NABF 1000-5-40	380	50	7,50	1.478	54.570	94
NABF 900-8-40	380	50	11,00	1.454	46.200	94
NABF 1000-8-40	380	50	15,00	1.456	62.250	97
NABF 1000-8-45	380	50	18,50	1.458	69.070	99
NABF 1120-8-40	380	50	22,00	1.471	86.620	100
NABF 1120-8-45	380	50	30,00	1.474	95.270	102

Değerler 0 Pa içindir.

OPSİYONLAR



KORUMA TELİ	KARŞI FLANŞ	KARŞI FLANŞ	KONNEKTÖR	TAKOZ	YAY	PANO
ÖLÇÜ	ÖLÇÜ	ÖLÇÜ	ÖLÇÜ	ÖLÇÜ	ÖLÇÜ	ÖLÇÜ
400	400	400	400	400	400	5,5 kW
450	450	450	450	450	450	7,5 kW
500	500	500	500	500	500	11,0 kW
560	560	560	560	560	560	15,0 kW
630	630	630	630	630	630	18,5 kW
710	710	710	710	710	710	22,0 kW
800	800	800	800	800	800	30,0 kW
900	900	900	900	900	900	
1000	1000	1000	1000	1000	1000	
1120	1120	1120	1120	1120	1120	



+90 533 576 25 71



www.nvsair.com



info@nvsair.com

DİĞER OPSİYONLAR



İstenilen Renkte
Elektro-Statik Toz Boya



Alüminyum veya Plastik
Kanat Seçeneği



İstenilen Debi ve
Basınca Özel Üretim



Sistem Otomasyonu



5, 8, 12 ve 16 Kanat
Adedi Seçenekleri



Çift Devirli Motor
Seçeneği

TEKNİK RESİM

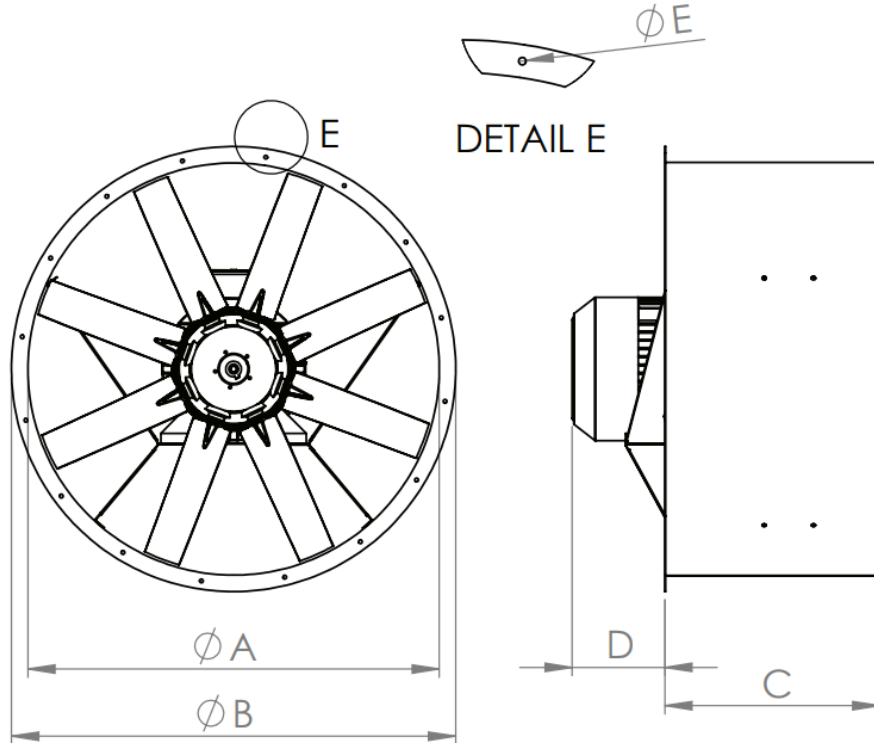

MODEL	A (mm)	B (mm)	C (mm)	D (mm)	E (mm)	N (Delik Sayısı)
NABF 400-5-25	400	480	320	30	11	8
NABF 450-5-25	450	530	320	50	11	8
NABF 500-5-25	500	580	320	70	11	8
NABF 560-5-25	560	640	320	60	11	12
NABF 630-5-30	630	710	420	45	11	12
NABF 710-5-30	710	790	420	25	11	12
NABF 800-5-30	800	880	420	50	11	16
NABF 800-5-35	800	880	420	50	11	16
NABF 900-5-35	900	980	520	0	11	16
NABF 900-5-40	900	980	520	35	11	16
NABF 1000-5-40	1000	1080	520	150	11	16
NABF 900-8-40	900	980	520	75	11	16
NABF 1000-8-40	1000	1080	520	180	11	16
NABF 1000-8-45	1000	1080	520	250	11	16
NABF 1120-8-40	1120	1200	800	250	11	16
NABF 1120-8-45	1120	1200	800	300	11	16



+90 533 576 25 71



www.nvsair.com



info@nvsair.com

PERFORMANS EĞRİLERİ

NABF 400-5-25

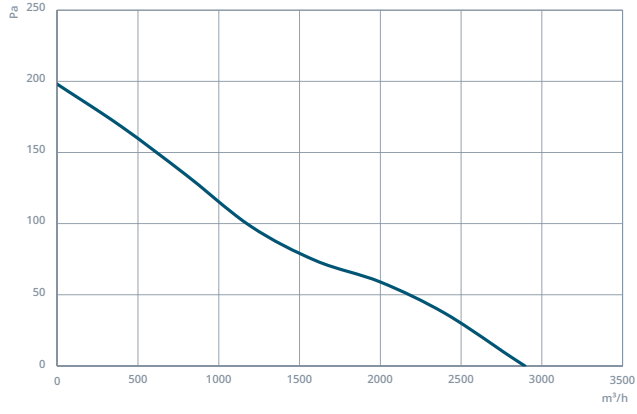

NABF 450-5-25

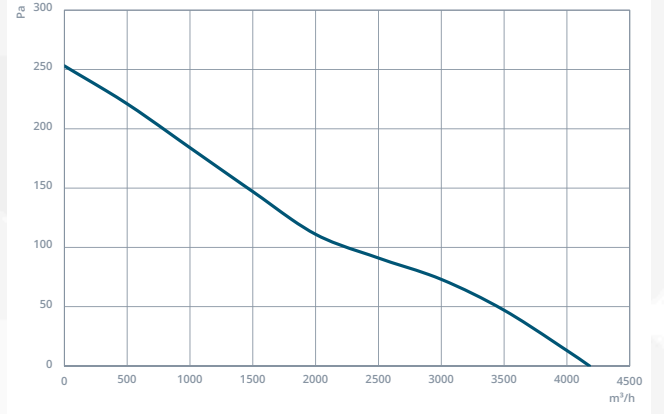

NABF 500-5-25

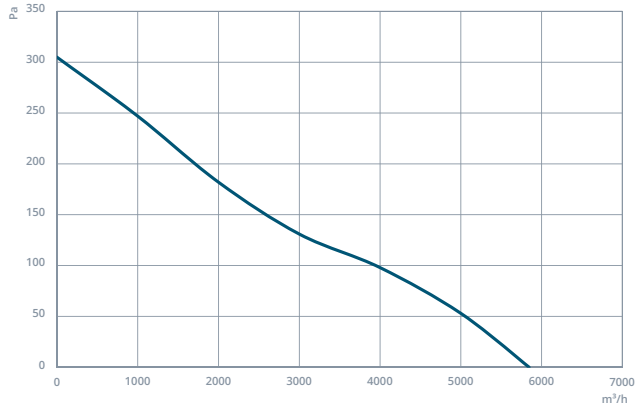

NABF 560-5-25

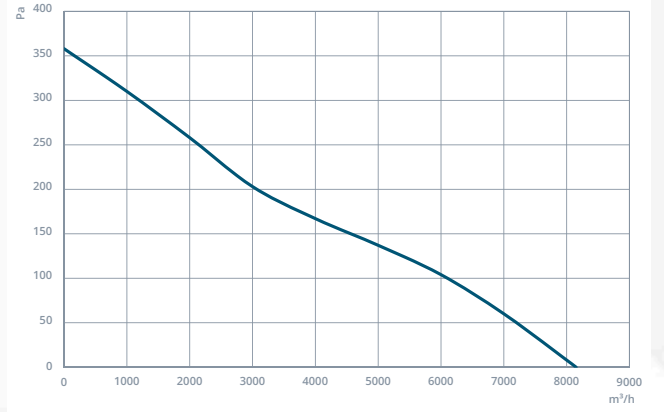

NABF 630-5-30

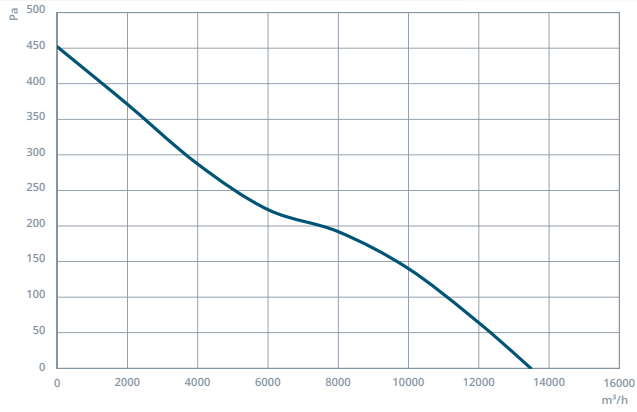

NABF 710-5-30

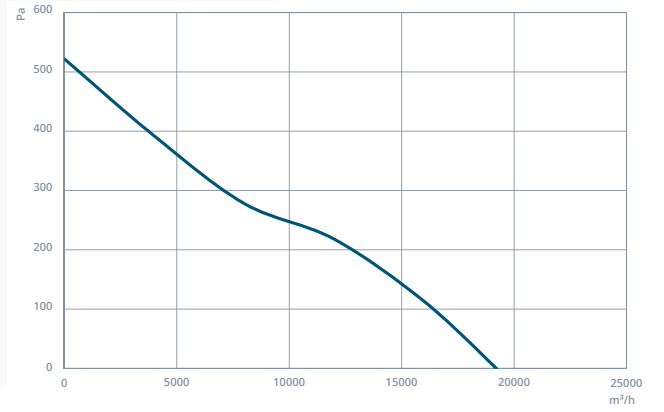

NABF 800-5-30

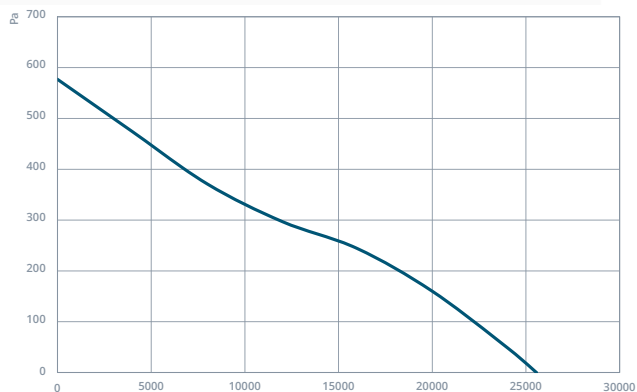

NABF 800-5-35

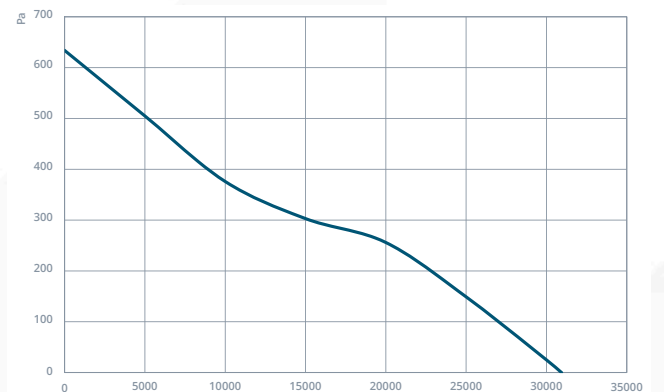

PERFORMANS EĞRİLERİ

NABF 900-5-35

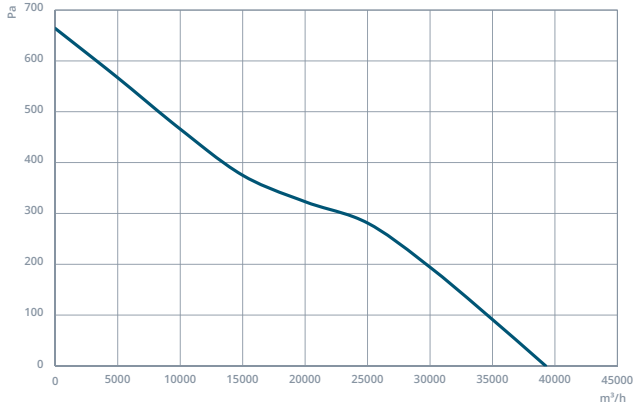

NABF 900-5-40

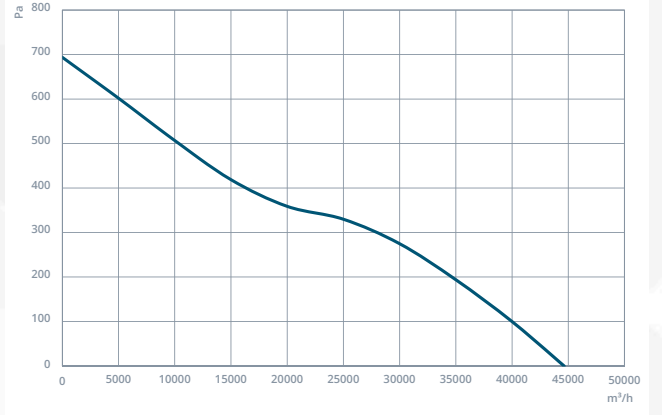

NABF 1000-5-40

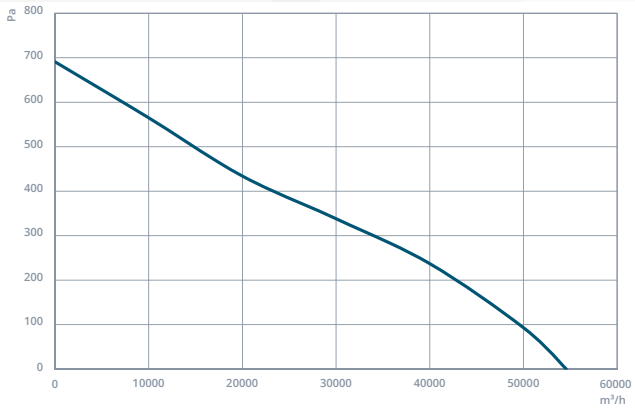

NABF 900-8-40

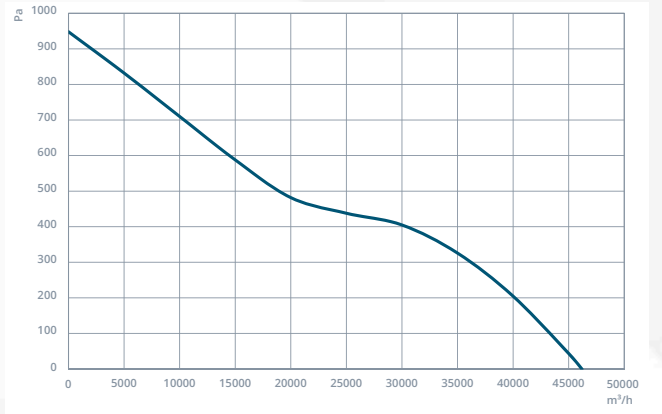

NABF 1000-8-40

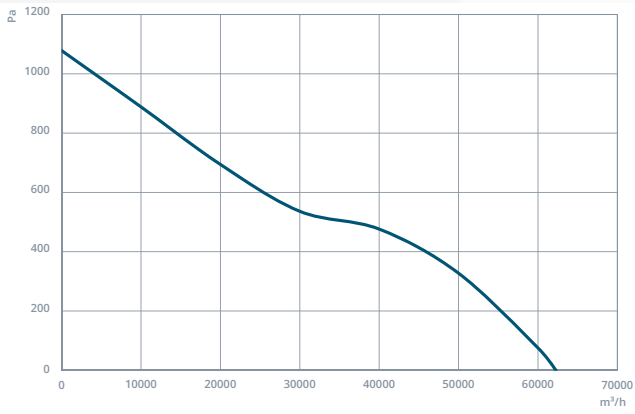

NABF 1000-8-45

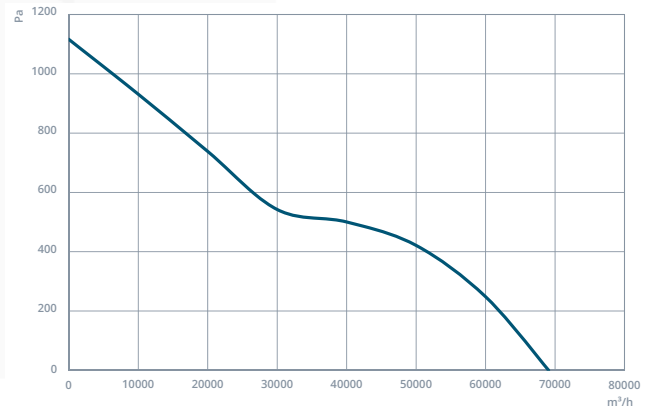

NABF 1120-8-40

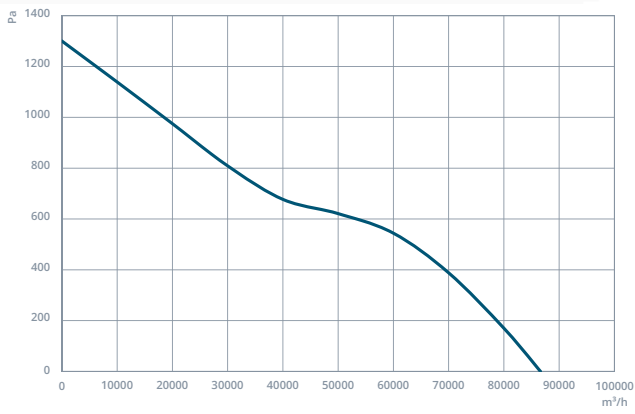

NABF 1120-8-45

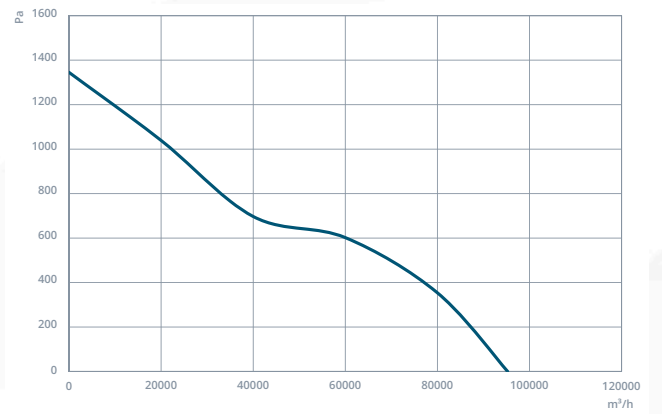



İLETİŞİM

.....

**Batı Sitesi Mah. 2310. Cad. No:50
Yenimahalle, Ankara, Türkiye**

Tel: +90 533 576 25 71

**info@nvsair.com
nvsair.com**