



NVSAIR

ventilation for life



ÜRÜN KATALOĐU

NSFS - Salyangoz Fan

► NSFS (Salyangoz Fan)

NSFS fanlar yüksek debili kanatları, dayanıklı gövdesi ve yönü değiştirilebilen üfleme ağız ile ihtiyaç duyduğunuz tüm havalandırma projelerinde kullanılabilir.

TANIM	DEĞER
MOTOR YALITIM SINIFI	F SINIFI
MOTOR KORUMA SINIFI	IP 55
MOTOR VERİM SINIFI	IE3
GÖVDE MALZEMESİ	GALVANİZE SAC
GÖVDE KAPLAMASI	ELEKTRO-STATİK TOZ BOYA
PERVANE MALZEMESİ	ALÜMİNYUM
GÖREV DÖNGÜSÜ	IEC Duty Cycle-
ÇALIŞMA SICAKLIĞI	S1 -20 - +50 °C
STANDARTLAR	EN 60204-1



Kanala Monte



Egzoz



Basınçlandırma



Motor Hava Akımının Dışında



MODEL	A (mm)	B (mm)	C (mm)	D (mm)	E (mm)	F (mm)
NSFS 280	380	400	600	180	140	250
NSFS 315	400	420	660	200	160	280
NSFS 355	385	410	720	250	170	300
NSFS 400	420	420	750	245	200	320
NSFS 450	445	445	820	300	226	350
NSFS 500	500	485	850	350	250	370
NSFS 560	620	712	1020	400	300	450
NSFS 630	660	735	1100	500	345	500
NSFS 710	750	760	1210	550	390	520

TEKNİK ÇİZİM

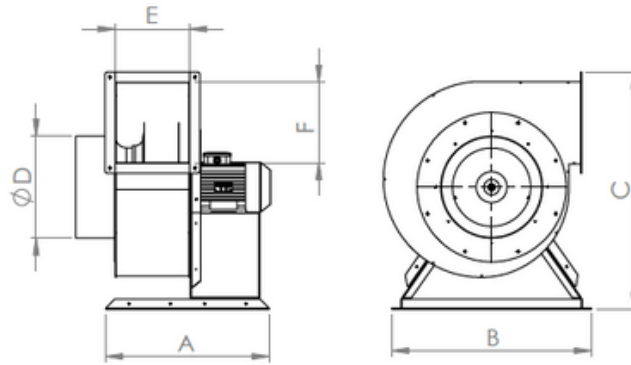

MODEL	VOLTAJ (V)	FREKANS (Hz)	GÜÇ (kW)	DEVİR (d/dk)	DEBİ (m³/h)	SES SEVİYESİ (dB(A))
NSFS 280	380	50	0,18	1.450	1.100	36
NSFS 315	380	50	0,25	1.469	1.600	37
NSFS 355	380	50	0,37	1.471	2.300	42
NSFS 400	380	50	0,55	1.478	3.300	45
NSFS 450	380	50	0,75	1.454	5.000	47
NSFS 500	380	50	1,10	1.462	7.000	49
NSFS 560	380	50	1,50	1.464	9.800	51
NSFS 630	380	50	3,00	1.465	14.000	54
NSFS 710	380	50	4,00	950	13.000	56

Değerler 0 Pa içindir

1,5 kW'a Kadar Monofaze Motor Takılabilir. Monofaze Motorlu İstenirse Mevcut Fiyata %20 Fark Uygulanır.



+90 533 576 25 71



www.nvsair.com



info@nvsair.com

7

PERFORMANS EĞRİLERİ

NSFS 280

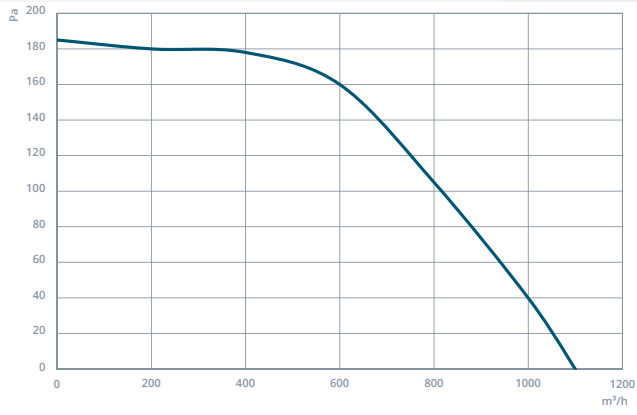

NSFS 315

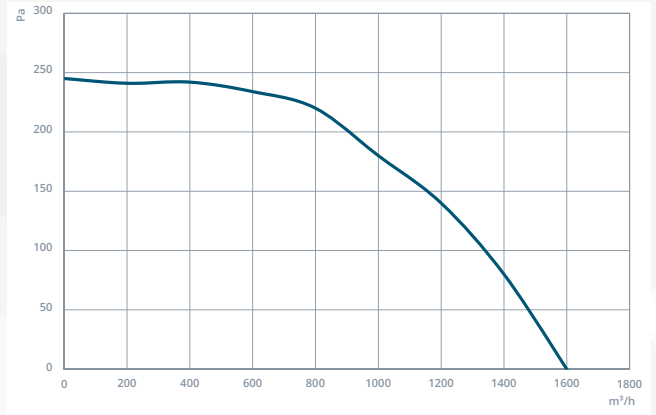

NSFS 355

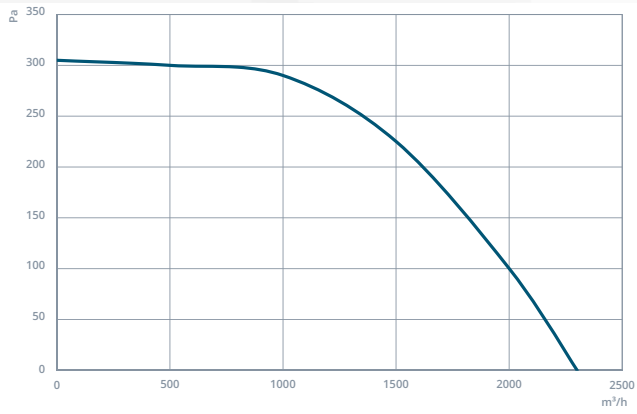

NSFS 400

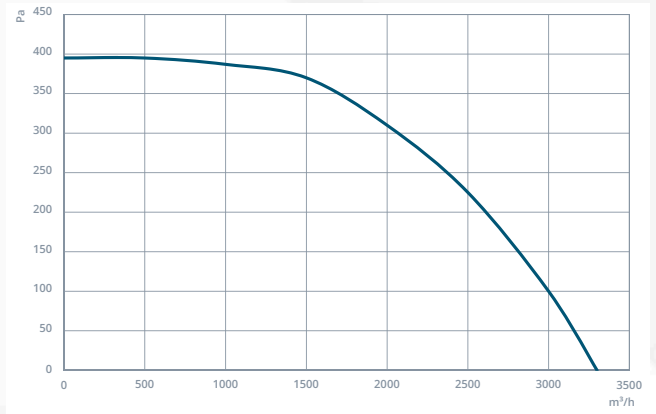

NSFS 450

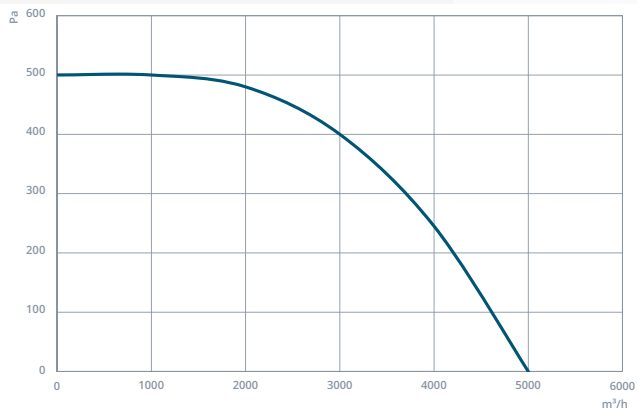

NSFS 500

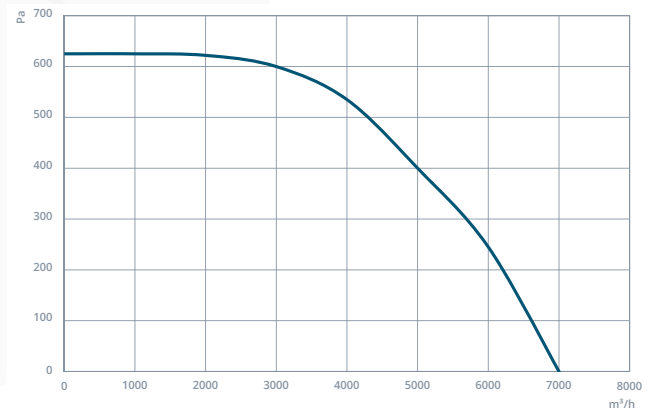

NSFS 560

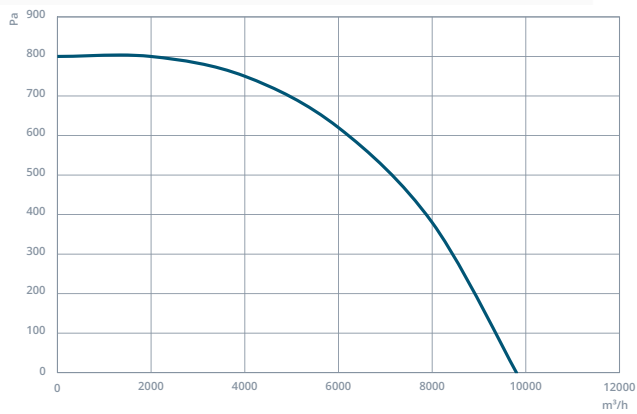

NSFS 630

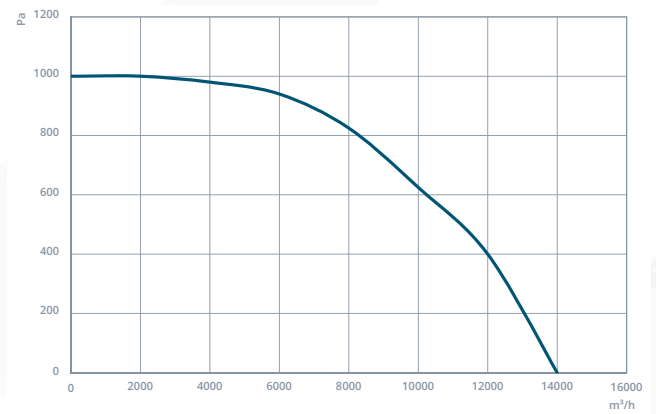

PERFORMANS EĞRİLERİ

NSFS 710

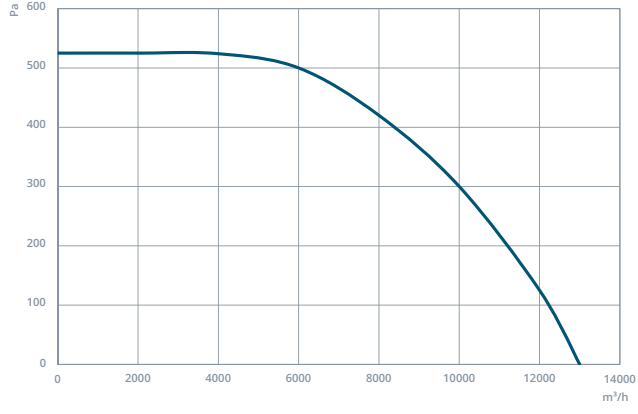



İLETİŞİM

.....

**Batı Sitesi Mah. 2310. Cad. No:50
Yenimahalle, Ankara, Türkiye**

Tel: +90 533 576 25 71

**info@nvsair.com
nvsair.com**