



NVSAIR

ventilation for life



PRODUCT CATALOGUE

NABF - Axial Pressurization Fan



+90 533 576 25 71



www.nvsair.com



info@nvsair.com

► NABF (Axial Pressurization Fan)

Axial Pressurization Fans are used in staircases, elevator shafts and other needs for pressurization. It can be used in high volume-low pressure systems.



DEFINITION	VALUE
MOTOR INSULATION CLASS	F CLASS
MOTOR PROTECTION CLASS	IP 55
MOTOR EFFICIENCY CLASS	IE3
MOTOR ENCLOSURE TYPE	TEFC
MOTOR BRAND	-
BODY MATERIAL	GALVANIZED SHEET METAL
BODY COATING	NONE
IMPELLER MATERIAL	ALUMINIUM
DUTY CYCLE	IEC Duty Cycle-S1
WORKING TEMPERATURE	-20 - +50 °C
STANDARDS	IEC-60335-2-80, ISO 1940-1

 **MOTOR IN THE AIRSTREAM**

 **PRESSURIZATION**

 **EXHAUST**

 **DUCT TYPE**



MODEL	VOLTAGE (V)	FREQUENCY (Hz)	POWER (kW)	REVOLUTION (rpm)	FLOW RATE (m³/h)	NOISE LEVEL (dB(A))
NABF 400-5-25	380	50	0,37	1.450	2.895	66
NABF 450-5-25	380	50	0,55	1.456	4.180	69
NABF 500-5-25	380	50	0,55	1.453	5.845	72
NABF 560-5-25	380	50	0,75	1.466	8.150	75
NABF 630-5-30	380	50	1,10	1.465	13.480	80
NABF 710-5-30	380	50	1,50	1.472	19.210	83
NABF 800-5-30	380	50	2,20	1.459	25.560	85
NABF 800-5-35	380	50	3,00	1.463	30.940	89
NABF 900-5-35	380	50	4,00	1.471	39.250	90
NABF 900-5-40	380	50	5,50	1.472	44.635	93
NABF 1000-5-40	380	50	7,50	1.478	54.570	94
NABF 900-8-40	380	50	11,00	1.454	46.200	94
NABF 1000-8-40	380	50	15,00	1.456	62.250	97
NABF 1000-8-45	380	50	18,50	1.458	69.070	99
NABF 1120-8-40	380	50	22,00	1.471	86.620	100
NABF 1120-8-45	380	50	30,00	1.474	95.270	102

Values are for 0 Pa.

OPTIONS

GRILL	SUPPORT FEET	FLANGE	CONNECTOR	RUBBER PAD	SPRING	PANEL
MEASUREMENT	MEASUREMENT	MEASUREMENT	MEASUREMENT	MEASUREMENT	MEASUREMENT	MEASUREMENT
400	400	400	400	400	400	5,5 kW
450	450	450	450	450	450	7,5 kW
500	500	500	500	500	500	11,0 kW
560	560	560	560	560	560	15,0 kW
630	630	630	630	630	630	18,5 kW
710	710	710	710	710	710	22,0 kW
800	800	800	800	800	800	30,0 kW
900	900	900	900	900	900	
1000	1000	1000	1000	1000	1000	
1120	1120	1120	1120	1120	1120	

OTHER OPTIONS



Electro-static Powder Coating With Any RAL Color



Aluminium or Plastic Blades



Custom Production For Any Flowrate and Pressure



System Automation



5, 8, 12 and 16 Blades Options



Two Speed Motor Option

DRAWING

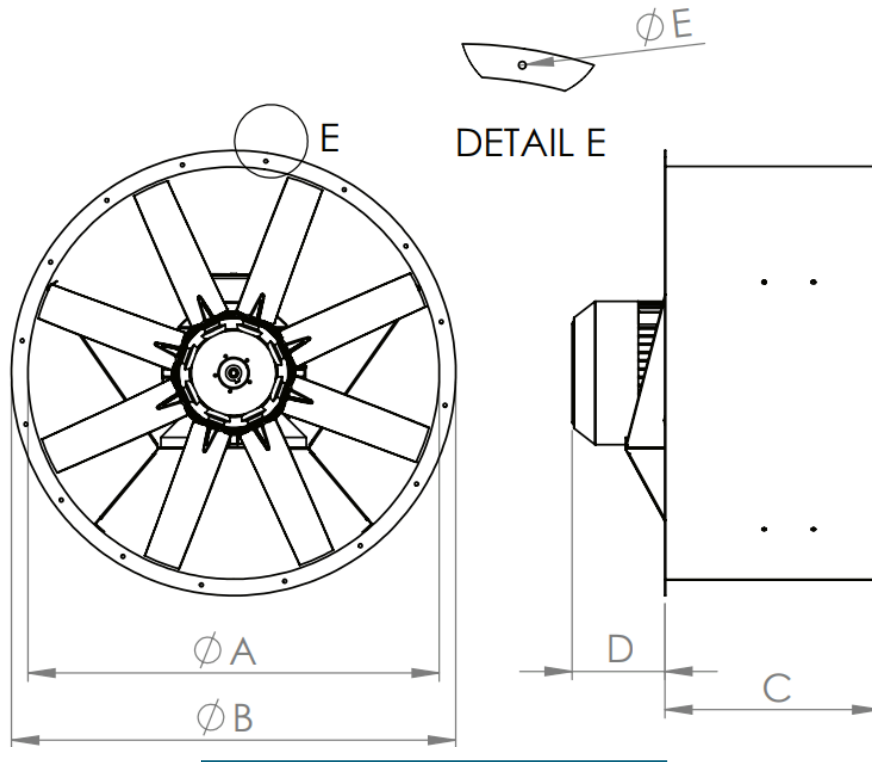

MODEL	A (mm)	B (mm)	C (mm)	D (mm)	E (mm)	N (Delik Sayısı)
NABF 400-5-25	400	480	320	30	11	8
NABF 450-5-25	450	530	320	50	11	8
NABF 500-5-25	500	580	320	70	11	8
NABF 560-5-25	560	640	320	60	11	12
NABF 630-5-30	630	710	420	45	11	12
NABF 710-5-30	710	790	420	25	11	12
NABF 800-5-30	800	880	420	50	11	16
NABF 800-5-35	800	880	420	50	11	16
NABF 900-5-35	900	980	520	0	11	16
NABF 900-5-40	900	980	520	35	11	16
NABF 1000-5-40	1000	1080	520	150	11	16
NABF 900-8-40	900	980	520	75	11	16
NABF 1000-8-40	1000	1080	520	180	11	16
NABF 1000-8-45	1000	1080	520	250	11	16
NABF 1120-8-40	1120	1200	800	250	11	16
NABF 1120-8-45	1120	1200	800	300	11	16



+90 533 576 25 71



www.nvsair.com



info@nvsair.com

PERFORMANCE CURVES

NABF 400-5-25

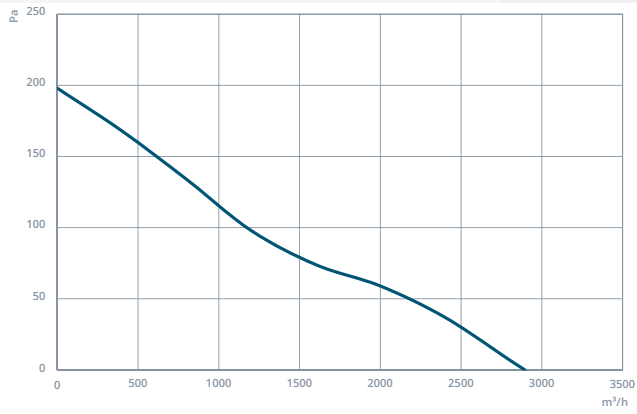

NABF 450-5-25

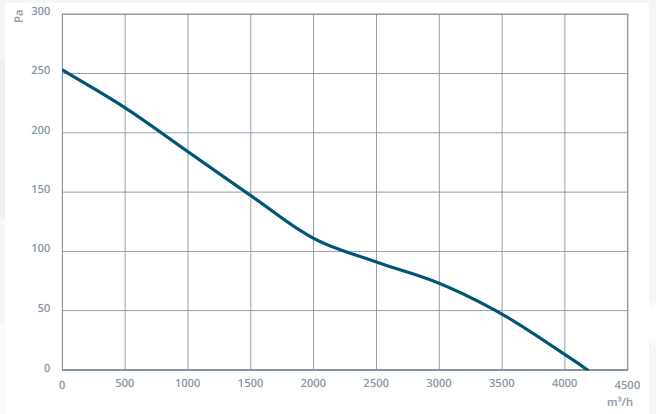

NABF 500-5-25

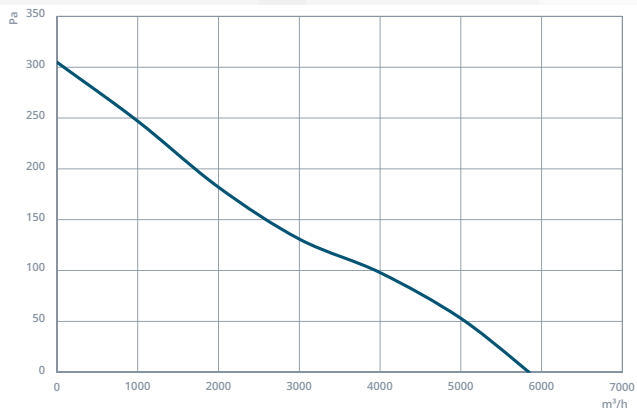

NABF 560-5-25

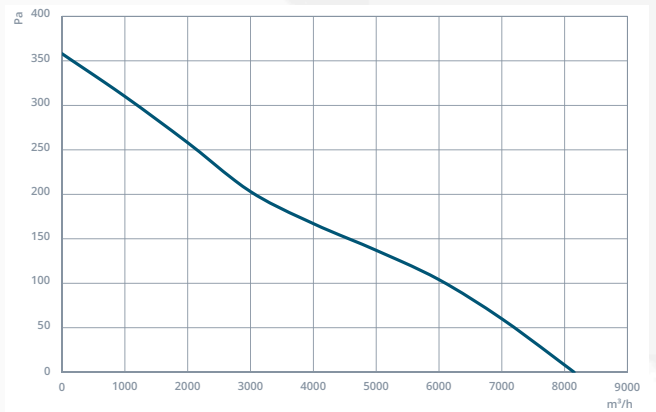

NABF 630-5-30

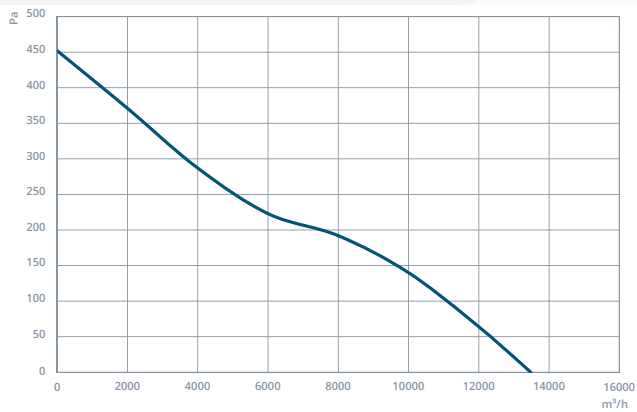

NABF 710-5-30

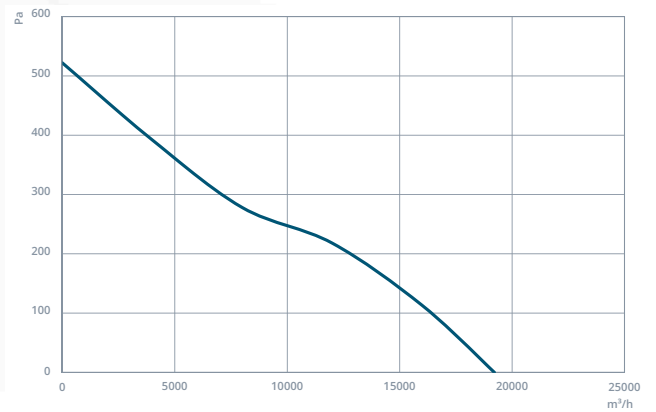

NABF 800-5-30

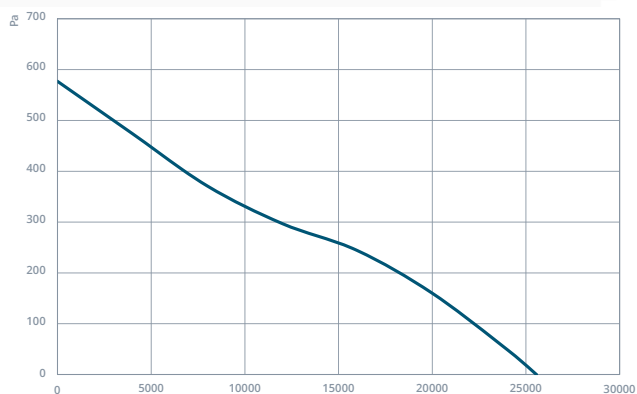

NABF 800-5-35

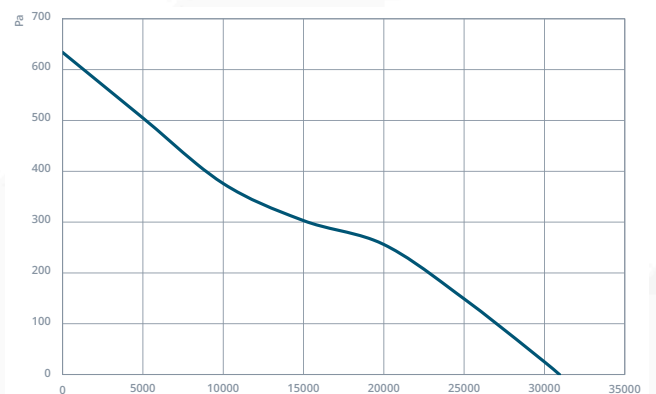

PERFORMANCE CURVES

NABF 900-5-35

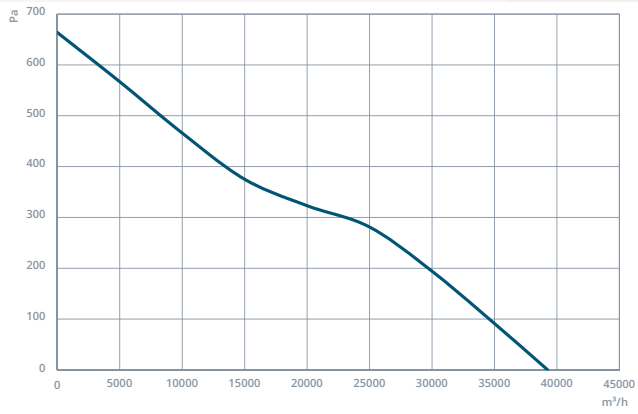

NABF 900-5-40

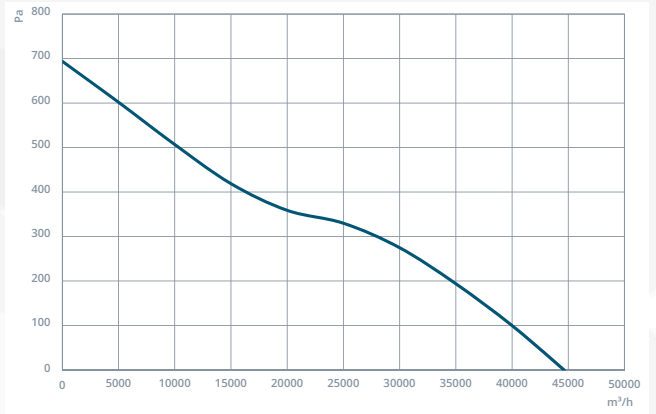

NABF 1000-5-40

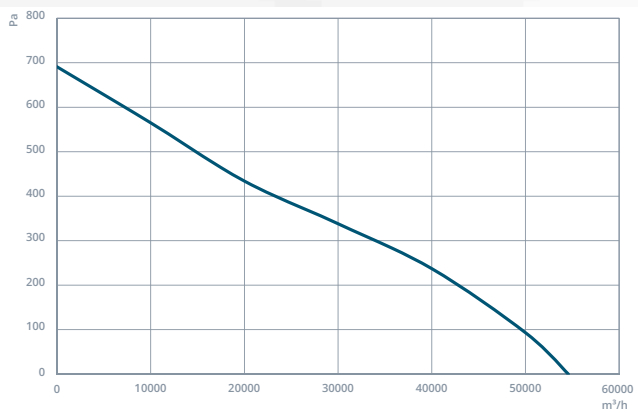

NABF 900-8-40

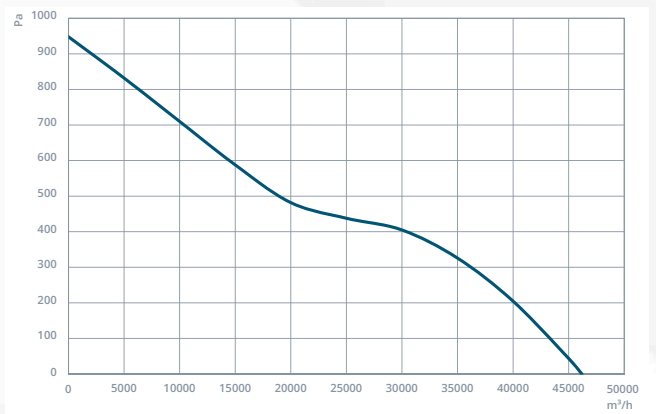

NABF 1000-8-40

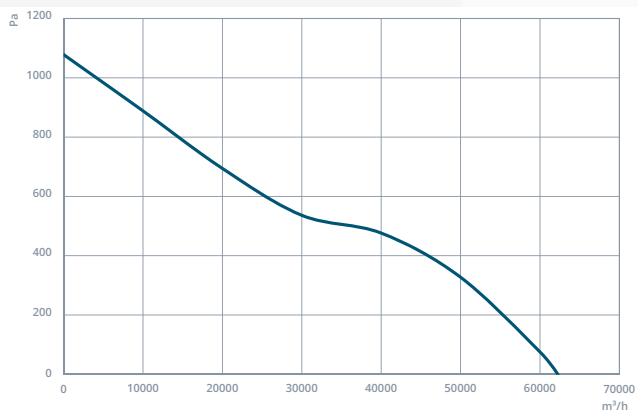

NABF 1000-8-45

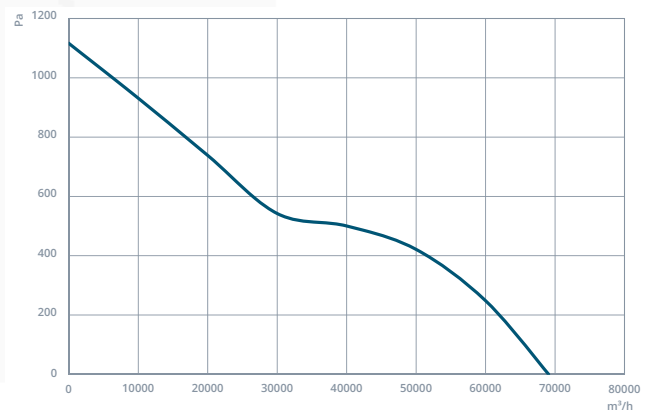

NABF 1120-8-40

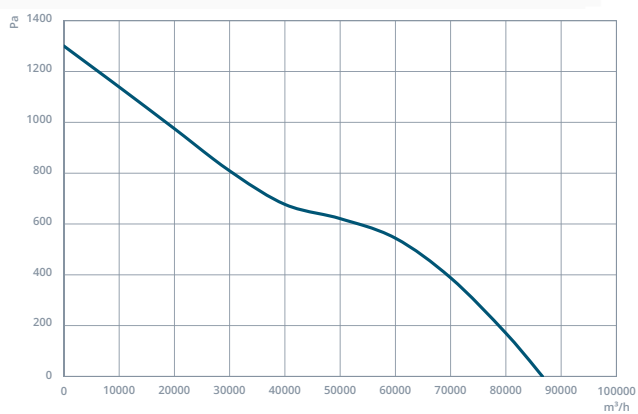

NABF 1120-8-45

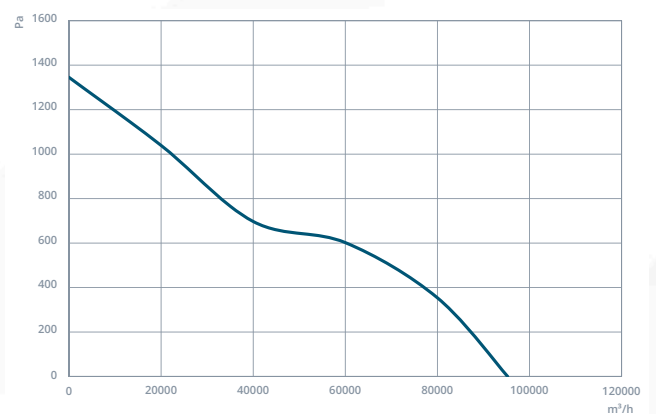



CONTACT

**Batı Sitesi Mah. 2310. Cad. No:50
Yenimahalle, Ankara, Türkiye**

P: +90 533 576 25 71

**info@nvsair.com
nvsair.com**