



NVSAIR

ventilation for life



PRODUCT CATALOGUE

NMF - Kitchen Exhaust Fan

► NMF (Kitchen Exhaust Fan)

NMF fans can be connected to kitchen hoods to exhaust the air from cookers, grilles, fryers etc. It will exhaust the greasy air and keeps the kitchen area clean and odorless. Inspection hatch allows cleaning the fan and maintenance. Motor is located out of the airstream and is not effected by matters in the air.



DEFINITION	VALUE
MOTOR INSULATION CLASS	F CLASS
MOTOR PROTECTION CLASS	IP 55
MOTOR EFFICIENCY CLASS	IE3
MOTOR ENCLOSURE TYPE	TEFC
MOTOR BRAND	-
BODY MATERIAL	GALVANIZED SHEET METAL
BODY COATING	ELECTRO-STATIC POWDER COATING
IMPELLER MATERIAL	ALUMINIUM
DUTY CYCLE	IEC Duty Cycle-S1
WORKING TEMPERATURE	-20 - +50 °C
STANDARDS	IEC-60335-2-80, ISO 1940-1

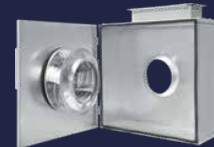

MOTOR OUT OF THE AIRSTREAM



EXHAUST



FOR KITCHEN



DUCT TYPE



MODEL	VOLTAGE (V)	FREQUENCY (Hz)	POWER (kW)	REVOLUTION (rpm)	FLOW RATE (m³/h)	NOISE LEVEL (dB(A))
NMF 315	380	50	0,25	1.469	1.600	37
NMF 355	380	50	0,37	1.471	2.300	41
NMF 400	380	50	0,55	1.478	3.300	42
NMF 450	380	50	0,75	1.454	5.000	45
NMF 500	380	50	1,10	1.462	7.000	49

Values are for 0 Pa.

Single-phase motors are available up to 1,5 kW

DRAWING

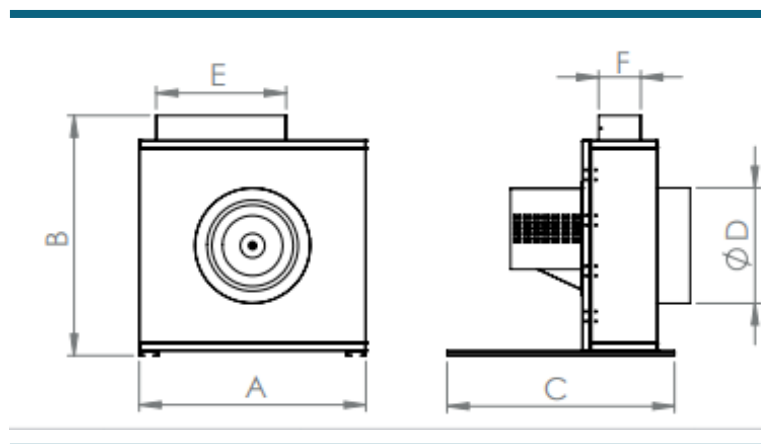

MODEL	A (mm)	B (mm)	C (mm)	D (mm)	E (mm)	F (mm)
NMF 315	650	690	700	315	300	110
NMF 355	700	740	700	355	400	130
NMF 400	750	790	700	400	400	150
NMF 450	800	840	700	450	400	170
NMF 500	850	890	700	500	440	190



+90 533 576 25 71



www.nvsair.com



info@nvsair.com

PERFORMANS EĞRİLERİ

NMF 315

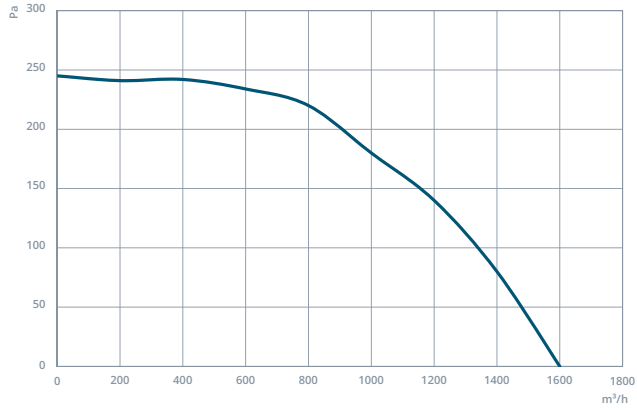

NMF 355

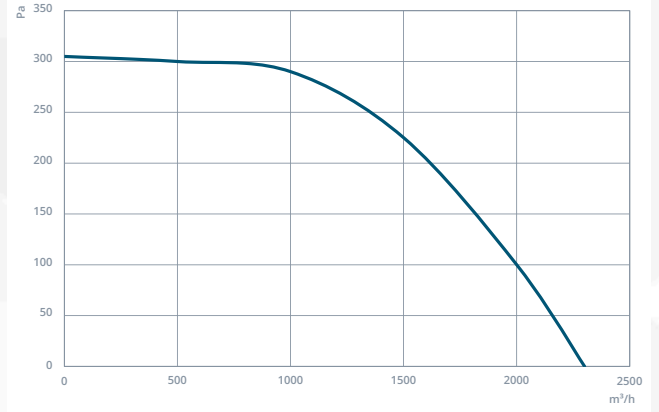

NMF 400

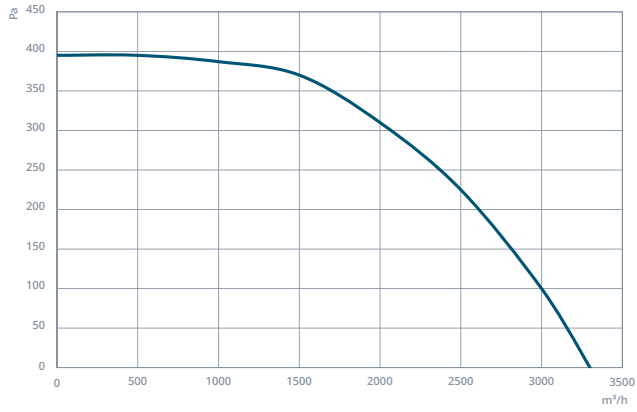

NMF 450

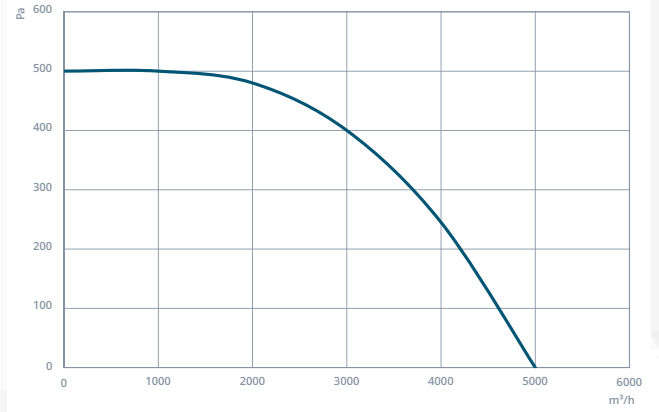

NMF 500

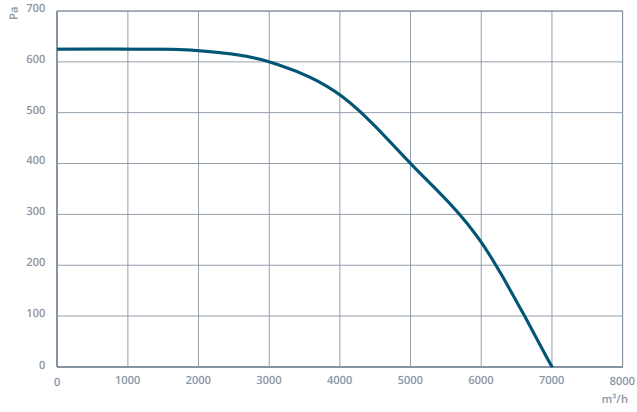



CONTACT

**Batı Sitesi Mah. 2310. Cad. No:50
Yenimahalle, Ankara, Türkiye**

P: +90 533 576 25 71

**info@nvsair.com
nvsair.com**